



Series 900

General

The 900 series consist of the following components:

- Pressure switch, which transforms a pneumatic signal into an electric one.
- Impulse generator, which transforms a permanent pneumatic signal into an adjustable impulse from 0 to 10 seconds.
- Pneumatic timer (N.C. or N.O.), which cuts or releases a pneumatic signal within an adjustable time.
- Two hands safety valve, which allows a safety use of two hands pneumatic controls (for example two push-button 3/2 N.C. to a certain distance) excluding false signals in case of push-button or valve malfunction.
- Flip - Flop: 5/2 ways valve, single signal actuated, commutes the outlet from 2 to 4 and vice versa at each puls.
- For a correct functioning it's important that inlet pressure be the same or lower than pilot pressure.
- Oscillator valve, 5/2 - G 1/8" with two logic functions "NOT" mounted on board, switches when the pressure in the connected cylinder exhaust chamber is reaching the threshold of "NOT".
- Signal amplifier, 3/2 - G 1/8" N.C. valve actuated by weak signals but higher than 0.05 bar.
- Progressive start-up valve, which is a device that is fitted in between valve or solenoid valve and cylinder allows a gradual filling of the chamber providing a low power cylinder movement. The progressive start-up valve is made of a flow control valve and a 2/2 N.C. valve with 6 mm nominal orifice. The valve is totally open when the pressure in the cylinder reaches 50% of inlet pressure.
- High-low pressure devices, located in the pneumatic circuit between valve and cylinder, allow the function of the cylinder with two different pressures. Example: in case of a locking action, it is possible to approach the required position at a low pressure, then increase to its maximum value in the circuit with the use of an electric signal. They are practically made of a piloted pressure regulator without relieving.

Construction characteristics

We use corrosion proof material, brass or anodized aluminium and the most appropriate specific mixture for seals. If more information is required please contact our technical department.

Use and maintenance

In use pay attention to the minimum and maximum criteria for temperature and pressure, checking and ensure good quality compressed air. In a dirty environment, protect the exhaust ports. In this case, maintenance is minimal and is necessary only if the air is particularly dirty. This simple operation it should be carried out by a competent person.

ATTENTION: use hydraulic oil class H for lubrication such as MAGNA GC 32 (Castrol).

► Pressure switch G 1/8" - screw connections

Coding: 900.18.1-**P**

Operational characteristics	
Fluid	Filtered air. No lubrication needed, if applied it shall be continuous
Max working pressure (bar)	10
Temperature °C	-5 ÷ +70
Flow rate microswitch	13 (3) A to 220V~
Pilot ports size	G1/8"

PRESSURE	
P	1 = Min. switch pressure 1 bar
	4 = Min. switch pressure 4 bar

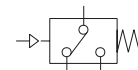
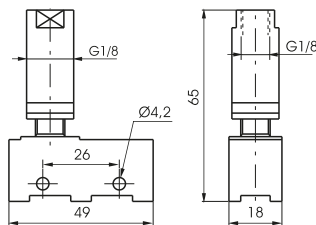

Weight 75 g

► Pressure switch G 1/8" - spade connections

Coding: 900.18.1/**P**

Operational characteristics	
Fluid	Filtered air. No lubrication needed, if applied it shall be continuous
Max working pressure (bar)	10
Temperature °C	-5 ÷ +70
Flow rate microswitch	16 (5) A to 220V~
Pilot ports size	G1/8"

PRESSURE	
P	1 = Min. switch pressure 1 bar
	4 = Min. switch pressure 4 bar

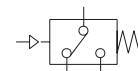
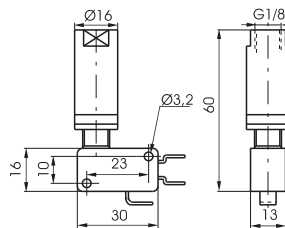

Weight 60 g

► Switch protection

Coding: 900.18.0

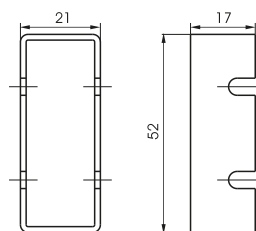

Weight 6 g

► Impulse generator

Coding: 900.18.2N

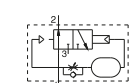
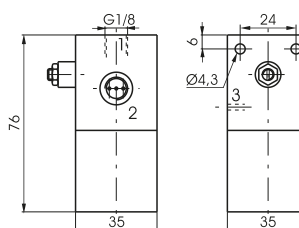

Weight 325 g

Pneumatic timer N.C. - G 1/8"

Coding: 900.18.T

Operational characteristics	
Fluid	Filtered air. No lubrication needed, if applied it shall be continuous
Max working pressure (bar)	3 ÷ 10
Temperature °C	-5 ÷ +70
Flow rate at 6 bar with $\Delta p=1$ (NI/min)	130
Orifice size (mm)	2.5

TIME	
① 3 =	0 ÷ 30 sec.
3-60 =	0 ÷ 60 sec.

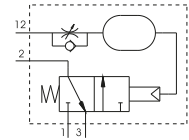
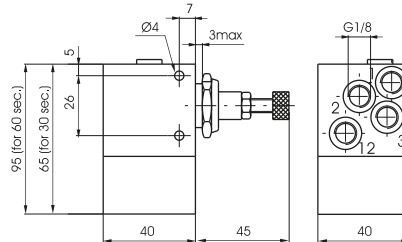

Weight 290 (30 sec.) g
weight 350 g (60 sec.)

Pneumatic timer N.O. - G 1/8"

Coding: 900.18.T

Operational characteristics	
Fluid	Filtered air. No lubrication needed, if applied it shall be continuous
Max working pressure (bar)	4 ÷ 10
Temperature °C	-5 ÷ +70
Flow rate at 6 bar with $\Delta p=1$ (NI/min)	130
Orifice size (mm)	2.5

TIME	
① 4 =	0 ÷ 30 sec.
4-60 =	0 ÷ 60 sec.

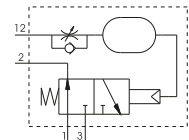
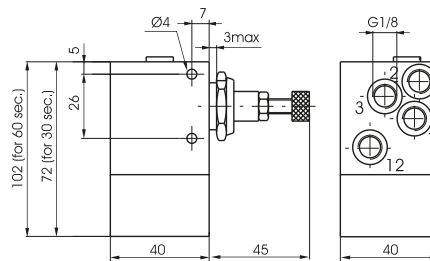

Weight 320 (30 sec.) g
weight 380 g (60 sec.)

Two hands safety valve G 1/4"

Coding: 900.52.1.1

Operational characteristics	
Fluid	Filtered air. No lubrication needed, if applied it shall be continuous
Max working pressure (bar)	10
Temperature °C	-5 ÷ +70
Flow rate at 6 bar with $\Delta p=1$ (NI/min)	1030
Orifice size (mm)	7
Working ports size	G1/4"
Pilot ports size	G1/8"

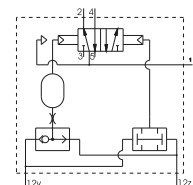
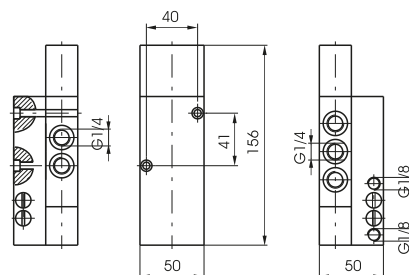

Weight 780 g

Two hands safety valve III A class certification (according to EN 574 standard)

Coding: 900.18.9

Operational characteristics	
Fluid	Filtered air. No lubrication needed, if applied it shall be continuous
Max working pressure (bar)	3 ÷ 8
Temperature °C	-5 ÷ +70
Flow rate at 6 bar with Δp=1 (NI/min)	40
Orifice size (mm)	2.5
Working ports size	G1/8"
Pilot ports size	G1/8"

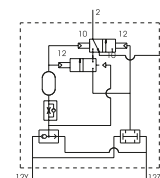
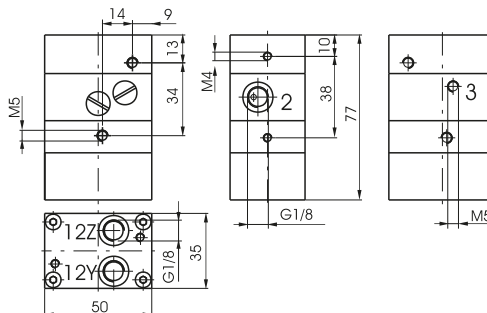

Weight 340 g

Two hands safety valve III B class certification (according to EN 574 standard)

Coding: 900.18.10

Operational characteristics	
Fluid	Filtered air. No lubrication needed, if applied it shall be continuous
Max working pressure (bar)	3 ÷ 8
Temperature °C	-5 ÷ +70
Flow rate at 6 bar with Δp=1 (NI/min)	40
Orifice size (mm)	2.5
Working ports size	G1/8"
Pilot ports size	G1/8"

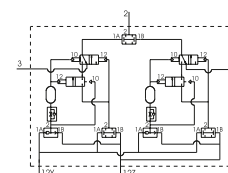
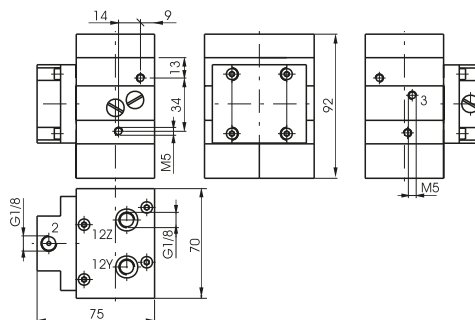

Weight 980 g

Power valve adaptor (Series 2400)

Coding: 900.18.11

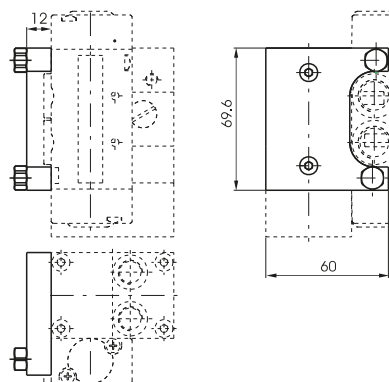

Weight 75 g

Flip-flop valve G 1/8" - Pneumatic command

Coding: 900.52.1.3

Operational characteristics	
Fluid	Filtered air. No lubrication needed, if applied it shall be continuous
Max working pressure (bar)	10
Temperature °C	-5 ÷ +70
Flow rate at 6 bar with $\Delta p=1$ (NI/min)	540
Orifice size (mm)	6
Working ports size	G1/8"

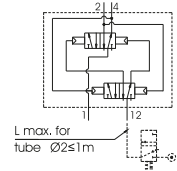
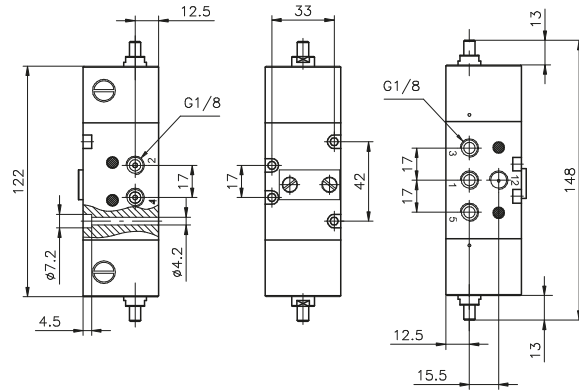

Weight 550 g

Attention : Pressure of signal "12" must be the same or higher than device inlet pressure. The maximum distance between the pilot valve and the device must not exceed 1Mtr. (see pneumatic scheme). Should be necessary to work at a greater distance it is advisable to use a pneumatic-spring shut-off valve positioned at the recommended distance.

Flip-flop valve - Electric command with M2 mechanic

Coding: 900.52.1.4

Operational characteristics	
Fluid	Filtered air. No lubrication needed, if applied it shall be continuous
Max working pressure (bar)	10
Temperature °C	-5 ÷ +70
Flow rate at 6 bar with $\Delta p=1$ (NI/min)	540
Orifice size (mm)	6
Working ports size	G1/8"

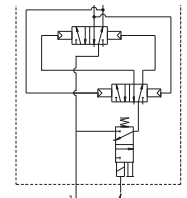
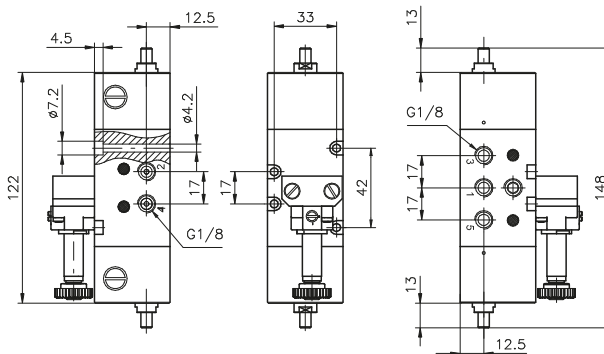

Weight 660 g

Flip-flop valve - Electric command with M3P CNOMO

Coding: 900.52.1.5

Operational characteristics	
Fluid	Filtered air. No lubrication needed, if applied it shall be continuous
Max working pressure (bar)	10
Temperature °C	-5 ÷ +70
Flow rate at 6 bar with $\Delta p=1$ (NI/min)	540
Orifice size (mm)	6
Working ports size	G1/8"

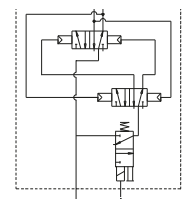
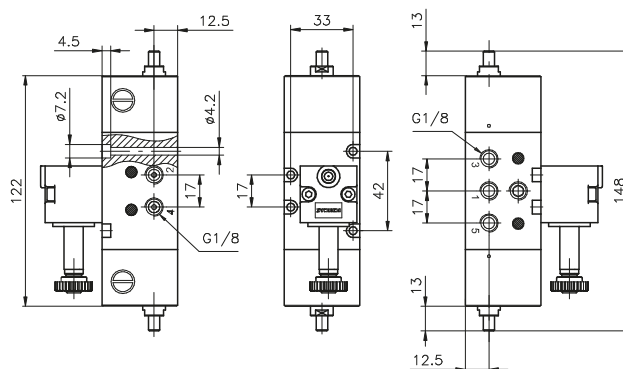

Weight 600 g

Oscillator valve G 1/8"

Coding: 900.52.6

Operational characteristics	
Fluid	Filtered air. No lubrication needed, if applied it shall be continuous
Max working pressure (bar)	8
Min working pressure	2
Temperature °C	-5 ÷ +70
Flow rate at 6 bar with Δp=1 (NI/min)	540
Orifice size (mm)	6
Working ports size	G1/8"

FUNCTION	
F	5 = without logic functions NOT
	5C = with logic functions NOT

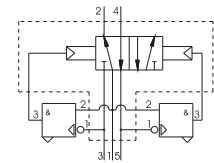
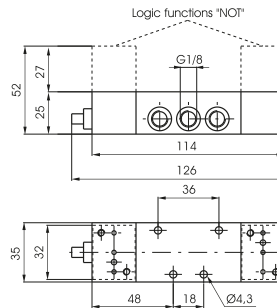

Weight 600 g

Signal amplifier G 1/8"

Coding: 900.32.6

Operational characteristics	
Fluid	Filtered air. No lubrication needed, if applied it shall be continuous
Max working pressure (bar)	10
Min working pressure	0.05
Temperature °C	-5 ÷ +70
Flow rate at 6 bar with Δp=1 (NI/min)	130
Orifice size (mm)	3
Working ports size	G1/8"

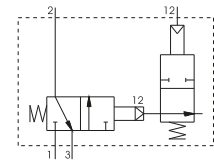
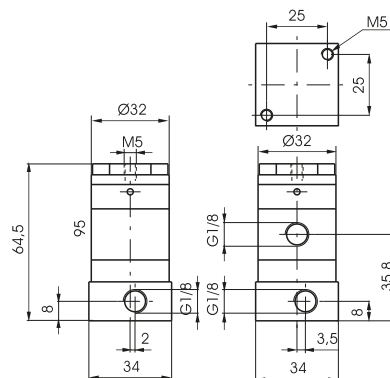

Weight 170 g

Progressive start-up valve G 1/4"

Coding: 900.14.7

Operational characteristics	
Fluid	Filtered air. No lubrication needed, if applied it shall be continuous
Max working pressure (bar)	2,5 ÷ 10
Temperature °C	-5 ÷ +70
Flow rate from 1 to 2 (NI/min)	760
Flow rate from 2 to 1 (NI/min)	900
Orifice size (mm)	6

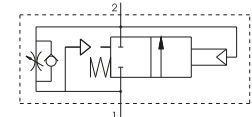
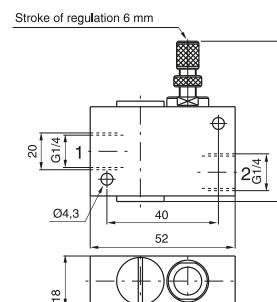

Weight 100 g
Flow rate needle fully open from port 1 to 2 (NI/min.) = 200

High-low pressure device

Coding: 900.18.8.P

Operational characteristics	
Fluid	Filtered air. No lubrication needed, if applied it shall be continuous
Max working pressure (bar)	10
Pressure range (bar)	1 ÷ 4
Temperature °C	-5 ÷ +50
Flow rate at 6 bar with $\Delta p=1$ (NI/min)	650
Working ports size	G1/8"

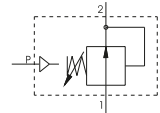
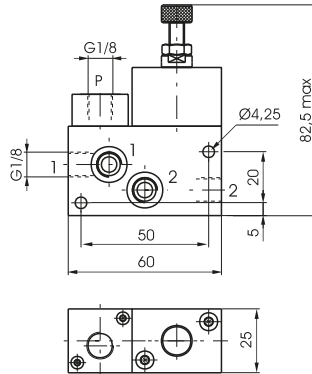

Weight 240 g
with pneumatic pilot

1
AIR DISTRIBUTION

High-low pressure device

Coding: 900.18.8.E

Operational characteristics	
Fluid	Filtered air. No lubrication needed, if applied it shall be continuous
Max working pressure (bar)	10
Pressure range (bar)	1 ÷ 4
Temperature °C	-5 ÷ +50
Flow rate at 6 bar with $\Delta p=1$ (NI/min)	650
Working ports size	G1/8"

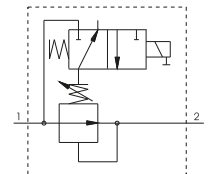
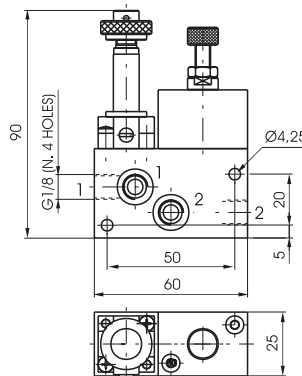

Weight 280 g
with M2 mechanic

External feeding base "NOT" logical element

Coding: 900.005

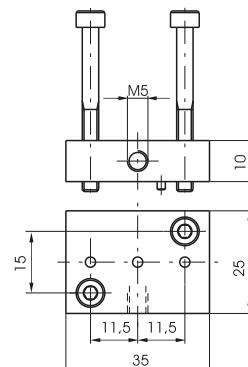

Weight 35 g

Pneumatic glue injector

Coding: 900.19.01

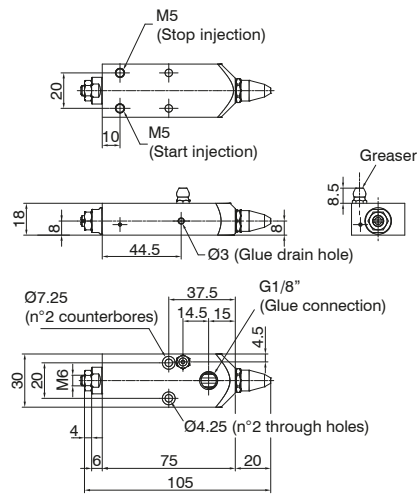

1
AIR DISTRIBUTION

Construction characteristics

- External components: nickel-plated brass / stainless steel
- Piloting connections: M5
- Glue connection: G1/8"
- Glue Seal: special PTFE
- Pneumatic seals: NBR
- Grease nipple: Stainless steel
- Spray intensity adjustment screw: Stainless steel

Technical characteristics

Technical characteristics	
Injection fluid	Vinyl glue
Pressure Glue (bar)	7
Pneumatic fluid piloting	Filtered air. No lubrication needed, if applied it shall be continuous
Opening pilot (bar)	3 ÷ 6
Closing pilot (bar)	3 ÷ 6 (or spring)
Temperature °C	-5 ÷ +70
Weight (g)	285