



Series 1260/1320 - Piston rod lock

General

The piston rod lock devices are clamping units mounted on the microbore cylinders front head. They allow the piston rod to lock in any position.

Piston rod clamping is mechanically obtained by springs actuated purpose-made jaws.

This method allows to lock the cylinder in the desired position, should the air pressure drop.

The piston rod lock device is not a safety device.

Construction characteristics

Mounting bracket	Anodised aluminium
Body	Anodised aluminium
Clamping jaws	Hardened alloy copper
Piston	Acetal resin
Seal	NBR
Springs	Springs steel

Operational characteristics

Fluid	Filtered air. No lubrication needed, if applied it shall be continuous.						
Working pressure	3 bar - 6 bar						
Working temperature	-5°C - +70°C						
Functioning	mechanical double jaws						
Locking	axial, two-direction (normally locked)						
Unlocking	pneumatic						
Clamping force	<u>Ø12</u>	<u>Ø16</u>	<u>Ø20</u>	<u>Ø25</u>	<u>Ø32</u>		
with static load (microbore cylinders)	180N	180N	350N	350N	600N		
Clamping force	<u>Ø32</u>	<u>Ø40</u>	<u>Ø50</u>	<u>Ø63</u>	<u>Ø80</u>	<u>Ø100</u>	<u>Ø125</u>
with static load (cylinders)	600N	1000N	1400N	2000N	5000N	5000N	7000N

"Attention: Dry air must be used for application below 0°C"

Use and maintenance

Operate within the specified technical characteristics.

The piston rod lock does not require maintenance if properly utilised.

The working inlet port has to be pressurised for assembling the piston rod lock device on cylinder. Alternatively adjust the jaws with screw located on connection.

Spare parts are not available.



Microbore cylinders for piston rod lock

Threaded end covers version

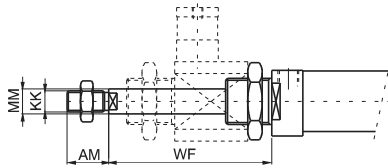

Ordering code	Order piston rod lock separately. Do not use with stainless steel or hexagonal piston rod.
12_ _Ø.stroke.B	

Cylinders for piston rod lock)

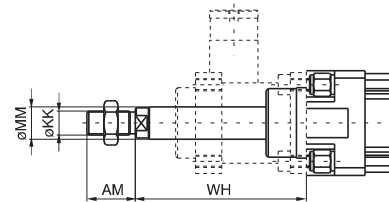

Ordering code	Order piston rod lock separately. Do not use with stainless steel piston rod.
13 --Ø.stroke.--B	

Piston rod lock complete

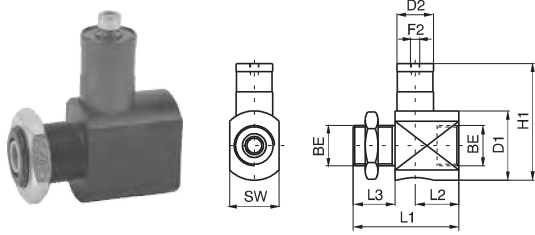

Do not use as safety device

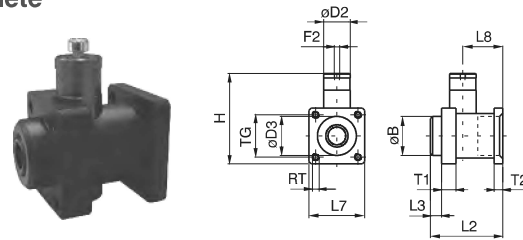

Ordering code	Ø	12	16	20	25	32
1260.Ø.51BS	Weight g	82	82	140	140	188

Ordering code	Ø	32	40	50	63	80	100	125
1320.Ø.51BS	Weight g	191	276	535	852	1772	2412	5250

Piston rod lock bracket

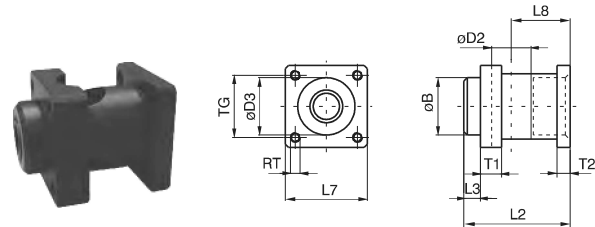
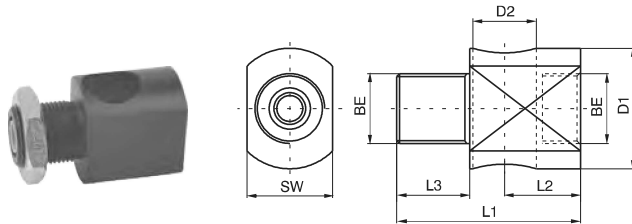

Ordering code	Ø	12	16	20	25	32
1260.Ø.51S	Weight g	60	60	85	85	133

Ordering code	Ø	32	40	50	63	80	100	125
1320.Ø.51S	Weight g	142	171	360	486	1060	1700	3500

Piston rod lock and housing

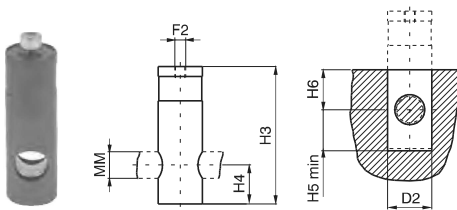

Do not use as safety device

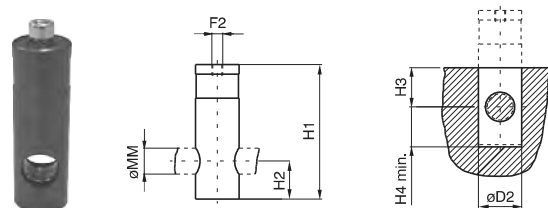

Ordering code	Ø	12	16	20	25	32
1260.Ø.51B (Ø12÷Ø25)	Weight g	22	22	55	55	55
1320.32.51B (Ø32)						

Ordering code	Ø	32	40	50	63	80	100	125
1320.Ø.51B	Weight g	49	105	175	366	712	712	1750

Table of dimensions (series 1200)

Bore	AM	BE	D1	D2	F2	H1	H3	H4	H5	H6	KK	L1	L2	L3	MM	SW	WF
12	16	M16x1,5	20	16	M5	35	35	10	11	10	M6x1	42	21	12	6	20	55
16	16	M16x1,5	20	16	M5	35	35	10	11	10	M6x1	42	21	12	6	20	55
20	20	M22x1,5	38	20	M5	64	62	17,5	19	18	M8x1,25	58	24	23	8	27	73
25	22	M22x1,5	38	20	M5	64	62	17,5	19	18	M10x1,25	58	24	23	10	27	77
32	20	M30x1,5	39,5	20	M5	64	62	17,5	18,5	18	M10x1,25	60	26	22	12	35	76,5

Table of dimensions (series 1300)

Bore	AM	B	D2	D3	F2	H	H1	H2	H3	H4	KK	L2	L3	L7	L8	MM	RT	T1	T2	TG	WH
32	22	30	20	30,5	M5	67	62	17,5	18	18,5	M10x1,25	58	10	45	31,5	12	M6	13	8	32,5	74
40	24	35	24	35	G 1/8"	86	83	22	22	23	M12x1,25	65	10	50	36	16	M6	13	8	38	85
50	32	40	30	40	G 1/8"	105	100	25	25	26	M16x1,5	82	12	60	45,5	20	M8	16	15	46,5	107
63	32	45	38	45	G 1/8"	121	116	30	30	31	M16x1,5	82	12	70	49,5	20	M8	16	15	56,5	107
80	40	45	48	45	G 1/8"	164	155	36	36	37	M20x1,5	110	20	90	61	25	M10	20	18	72	126

Series 1260 - 1320 - Linear control units

Construction characteristics

Body	extruded shape anodized aluminium alloy 6060
Bushings	sintered bronze
Wiper	oil resitant NBR rubber
Rods	chromed C43 steel
Plate	plated zinc steel
Mounting block	plated zinc steel

Technical characteristics

Max. suggested strokes for 1200 series:

Diameter	20	25
Stroke mm	200	250

Max. suggested strokes for 1320 series:

Diameter	32	40	50	63	80
Stroke mm	300	350	450	500	550

On request are available strokes up to 2800 mm

Loading diagram based on dimension "A"

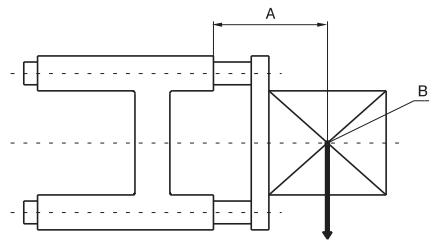

A = Protusion
B = Load centre of gravity

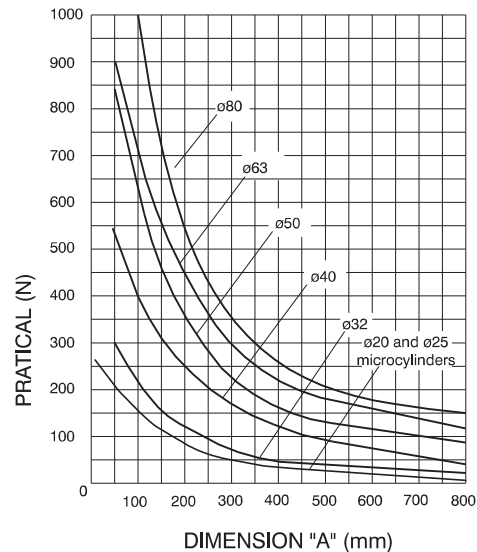

Use and maintenance

Follow the indication of the above diagram as far as loads are concerned. A large quantity of grease is placed between the two wipers during assembly, therefore the linear control units should not require special maintenance.



Dimensions for microbore cylinders ISO 6432

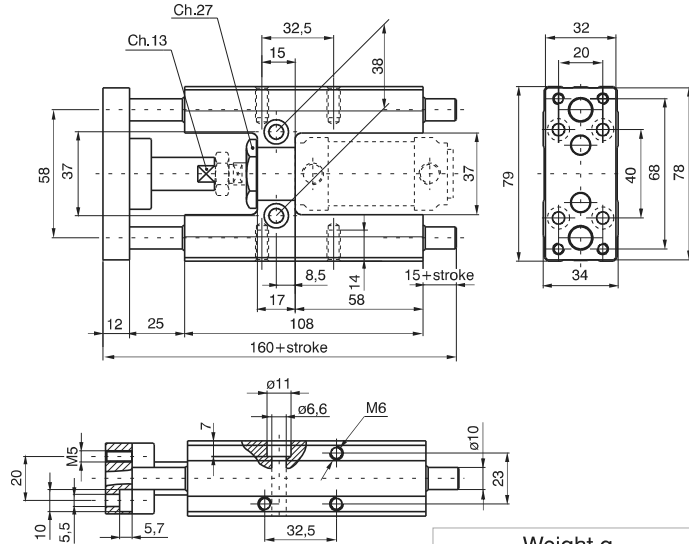

Ordering code
1260.Ø.stroke.GLB
(Microbore cylinders ISO 6432 must be ordered separately)

Standard strokes
Ø 20 100 - 150 - 200 mm
Ø 25 100 - 150 - 200 - 250 mm

Weight g	
stroke 100	every 50 mm
970	60

Sensors and sensor clamps: Use standard sensors and clamps.

Dimensions for microbore cylinders ISO 15552

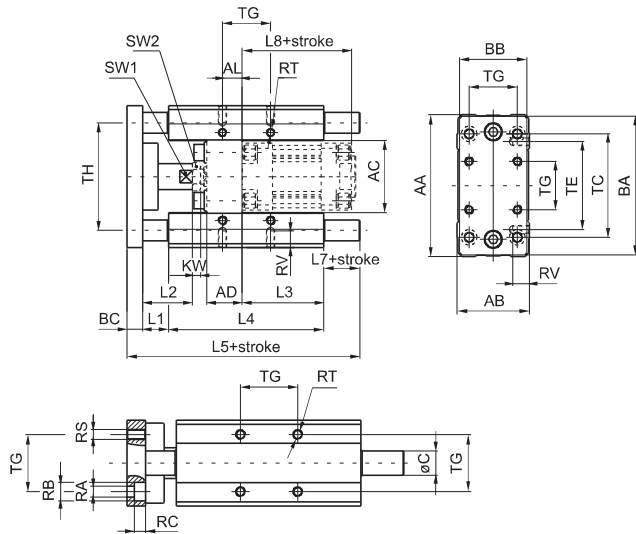

Ordering code
1320.Ø.stroke.GLB
(Cylinders must be ordered separately)

		Bore	Ø32	Ø40	Ø50	Ø63	Ø80
Weight g	stroke 100	1720	2900	4700	6000	11300	
	every 50 mm	91	159	159	250	380	

Bore	AA	AB	AC	AD	AL	BA	BB	BC	C	KW	L1	L2	L3	L4	L5
32	97	49	50	24	4.3	93	45	12	12	6	25	39	76	125	187
40	115	58	57.5	28	11	112	55	12	16	7	25	44	81	140	207
50	137	70	69.5	34	18.8	134	65	15	20	8	25	48	79	150	225
63	152	85	84.5	34	15.3	149	80	15	20	8	25	48	111	182	242
80	189	105	106	34	21	180	100	20	25	9	25	53	128	215	302

Bore	L7	L8	RA	RB	RC	RS	RT	RV	SW1	SW2	TC	TE	TG	TH
32	25	94	6.6	11	6.5	M6	M6	12	15	17	78	61	32.5	74
40	30	105	6.6	11	6.5	M6	M6	14	15	19	84	69	38	87
50	35	106	9	15	9	M8	M8	16	22	24	100	85	46.5	104
63	20	121	9	15	9	M8	M8	16	22	24	105	100	56.5	119
80	42	128	11	18	11	M10	M10	20	27	24	130	130	72	148

Standard strokes

- Ø 32 100 - 150 - 200 - 250 - 300 mm
- Ø 40 100 - 150 - 200 - 250 - 300 - 350 mm
- Ø 50 100 - 150 - 200 - 250 - 300 - 350 - 400 - 450 mm

Sensor clamps and brackets for 1319-1320 series
Use standard sensors and brackets on the rear and following special brackets on front of cylinders for use sensors codes 1500_ , RS_ , HS_ which have the following ordering codes:

- 1320.AGL** sensor bracket for cylinders Ø32 and Ø40
- 1320.BGL** sensor bracket for cylinders Ø50 and Ø63