



twisterchain

Circular and spiral movements



twisterchain advantages:

- e-chains® for circular and spiral movements up to 360°, from stock (up to 400° upon request)
- Tough, quiet and high dynamics, suitable for high fill weights
- Rotary speeds up to 1m/s and more
- Modular interior separation
- Smooth cable-friendly interior
- Openable from both sides - crossbars removable along the inner and outer radius



When to use another igus® solution:

- For large rotary movements, igus® *RBR* solutions
 - ▶ **Designing, page 130**
- In case of rotary movements in the most confined spaces up to 7,000°
 - ▶ **twisterband, page 1108**
- For angle of rotation >360° please contact us.

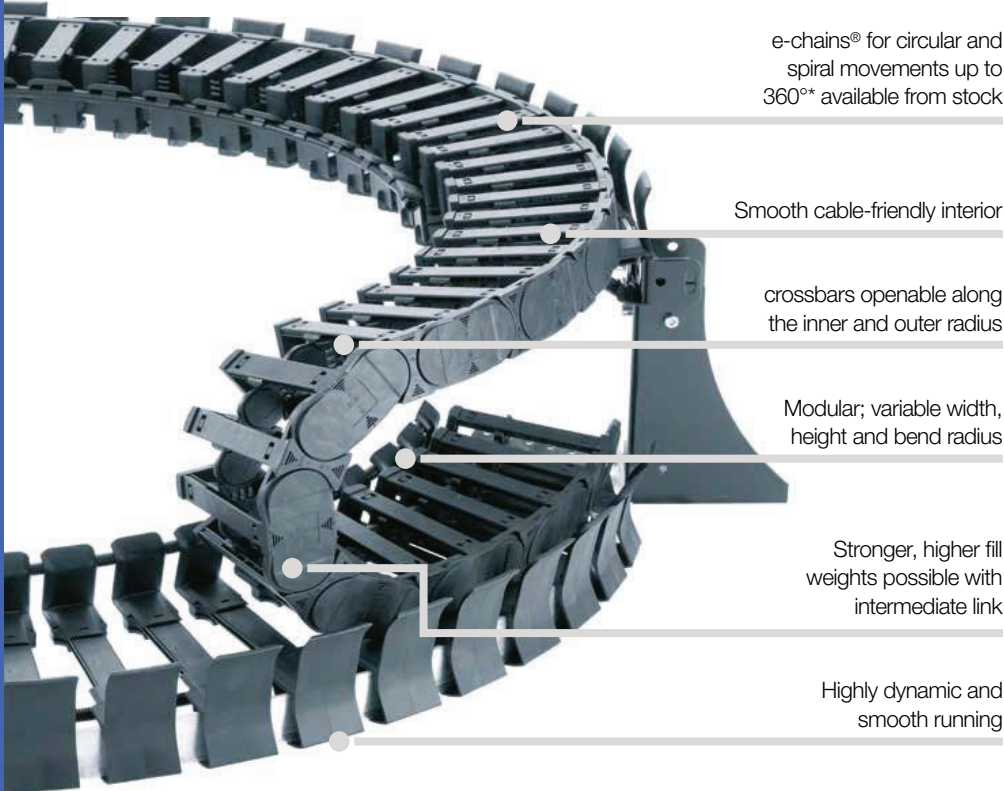

e-chains® for circular and spiral movements up to 360°* available from stock

Smooth cable-friendly interior

crossbars openable along the inner and outer radius

Modular; variable width, height and bend radius

Stronger, higher fill weights possible with intermediate link

Highly dynamic and smooth running

Strong, quiet and up to 360° - circular and spiral movements - twisterchain

The igus® twisterchain product line offers an extensive range of products for circular movement and is available in four sizes. Its modular width and radius design ensures it can be used flexibly in applications with rotary and spiral movements up to 360° and more, with high fill weights and where smooth operation is required. twisterchain applications are available with modular guide troughs which offer: e-chain® guidance, reduced e-chain® wear, optimal levels of smooth operation, angle of rotations up to 360° from stock.

- Strong, high fill weights, smooth running
- Rotary speeds up to 1m/s and more
- e-chains® for circular and spiral movements up to 360°, from stock (up to 400° upon request)
- Cable-friendly, smooth interior ● Crossbars openable along the inner and outer radius
- Successfully tested for over 1 million cycles in the igus® laboratory

Typical industries and applications

- Robots, Handling machines ● Packaging machines ● Glass machines ● General machinery, etc.

 e-chains® for circular movements up to 360° available from stock (up to 400° upon request)

 UL94-V0 classification upon request

Series	Inner height <i>hi</i> [mm]	Inner width <i>Bi</i> [mm]	Outer width <i>Ba</i> [mm]	Outer height <i>ha</i> [mm]	Bend radius <i>R</i> [mm]	Circular radii <i>AR</i> [mm]	Page
--------	--------------------------------	-------------------------------	-------------------------------	--------------------------------	------------------------------	----------------------------------	------

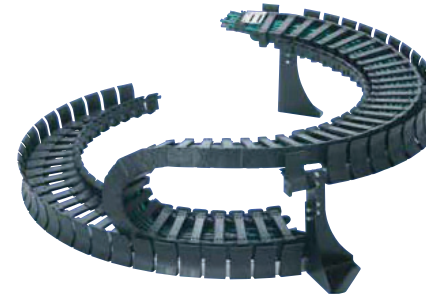

twisterchain

for rotary movements up to 360° available from stock; for angle of rotation >360° please contact us. Crossbars removable along the inner and outer radius

2208.*	28	52.5 - 112.5	80 - 140	42	055 - 150	300	1092
TC32	32	87.5 - 150	108.5 - 171	54	100 - 250	400 - 600	1094
TC42	42	87.5 - 200	110.5 - 223	64	100 - 250	400 - 850	1096
TC56	56	125 - 200	155 - 230	84	150 - 400	650 - 850	1098

*twisterchain classic (1st generation), openable from both sides



Available from stock. Ready to ship in 3 - 5 days*

*Average time before the ordered goods are dispatched.

Quickly generate complete twisterchain 3D CAD models

- Get complete 3D models just by inputting the angle of rotation and basic dimensions
 - Free positioning of the e-chain® moving end along the travel length
 - Optional generation of twisterchain as a single part or complete with guide trough and base support
 - Fast download of the CAD files without registration
 - 11 different 3D and 8 different 2D CAD formats are available
- More information ► www.igus.eu/twister-configurator

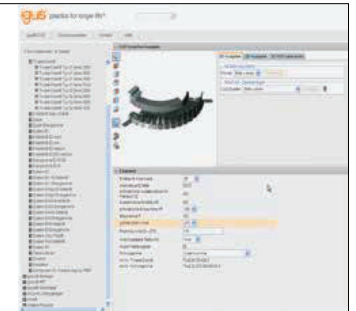

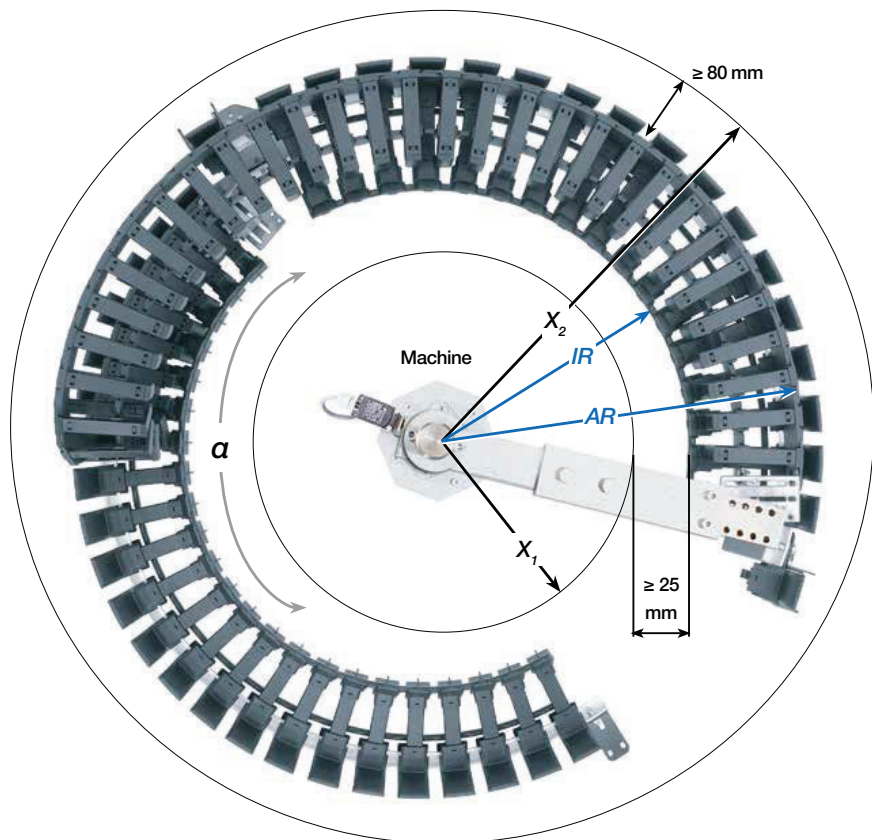

twisterchain general information

In the case of machines which rotate in one direction then the other, the total rotation angle required is the sum of the two angles.

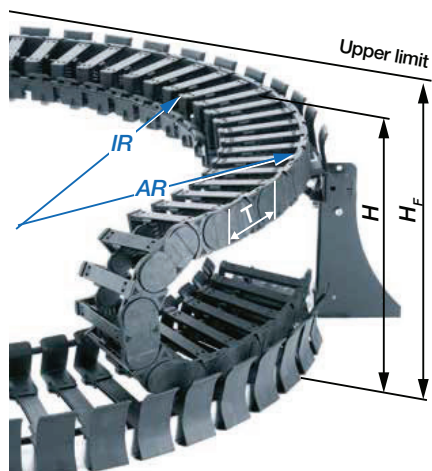
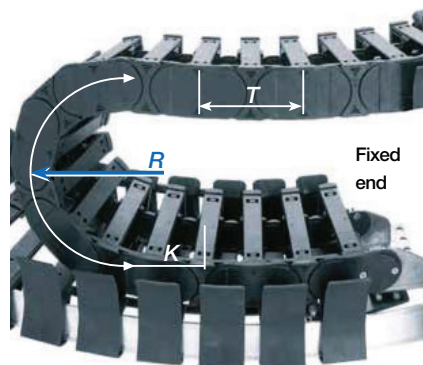

AR = Outer radius e-chain®
IR = Inner radius e-chain®
R = Bend radius e-chain®
X₁ = Inner machine limit
X₂ = Outer machine limit
T = Pitch

H_f = e-chain® height incl. 50mm clearance
H = e-chain® height
K = Add-on for bend radius
hi = Inner height e-chain®
ha = Outer height e-chain®
α = Angle of rotation

Technical data

	Speed / acceleration	upon request
	Material - permitted temperature °C, igumid G	-40°C / +120°C
	Flammability class, igumid G	VDE 0304 IIC UL94-HB

Order example | Order key

Order example for complete e-chain® (1.0m), colour black, with mounting brackets:

e-chain® (1.0m)	Please indicate e-chain® length or odd* number of links: 1.0m or 11 links	TC56.12.250/650.0
+ Mounting brackets	1 set	TC5600.34.VS.E
Order text:	1m TC56.12.250/650.0 + TC5600.34.VS.E	

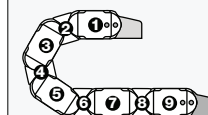

***Important note:**
 twisterchain e-chains® must always start and end on an outer side link (odd number of links).
 An outer side link should always be the first link at the moving end.



Order key

TC56.12.250/650.0

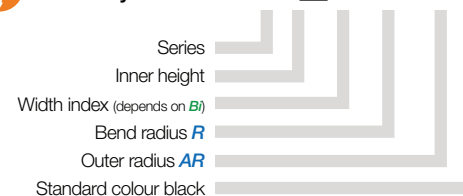

TC56.12.250/650.0 =
 e-chain® openable along the inner radius, from both sides
Bi 12mm inner width, **R** 250mm bend radius /
AR 650mm outer radius, colour black

Series 2208 | Crossbars removably along the inner and outer radius

AR	IR	Bi	Ba	R 055 [mm]	R 063 [mm]	R 075 [mm]	R 100 [mm]	R 125 [mm]	R 150 [mm]	2208
[mm]	[mm]	[mm]	[mm]	2208 ...	2208 ...	2208 ...	2208 ...	2208 ...	2208 ...	[kg/m]
300	227	52.5	80	.052.063/300	.052.063/300	.052.075/300	.052.100/300	.052.125/300	.052.150/300	≈ 1.20
300	217	62.5	90	-	-	.062.075/300	.062.100/300	.062.125/300	.062.150/300	≈ 1.24
300	205	74.5	102	-	-	-	.074.100/300	.074.125/300	.074.150/300	≈ 1.29
300	192	87.5	115	-	-	-	.087.100/300	.087.125/300	.087.150/300	≈ 1.35
300	167	112.5	140	-	-	-	-	.112.125/300	.112.150/300	≈ 1.46

*twisterchain classic (1st generation),

R	055	063	075	100	125	150	Pitch [mm/link]	44
K	265	290	330	410	485	565	Links/m	23
							corresponds to [mm]	1,012

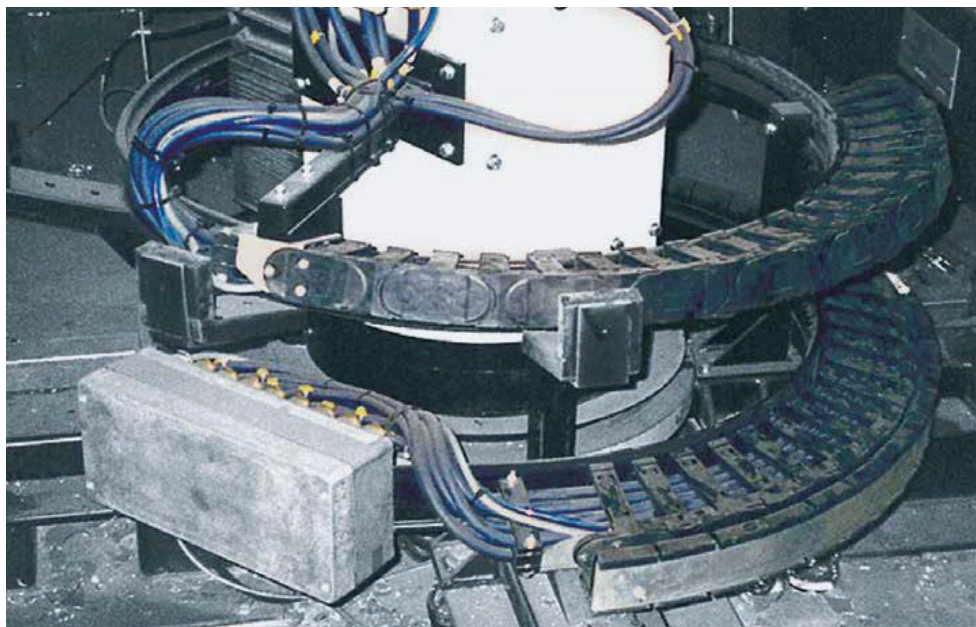
Combined spiral and rotary movement - igus® twisterchain classic (1st generation)

Dimensions

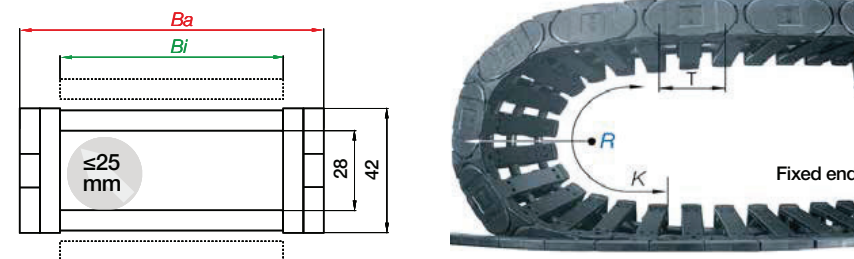

Series 2208 | Interior separation

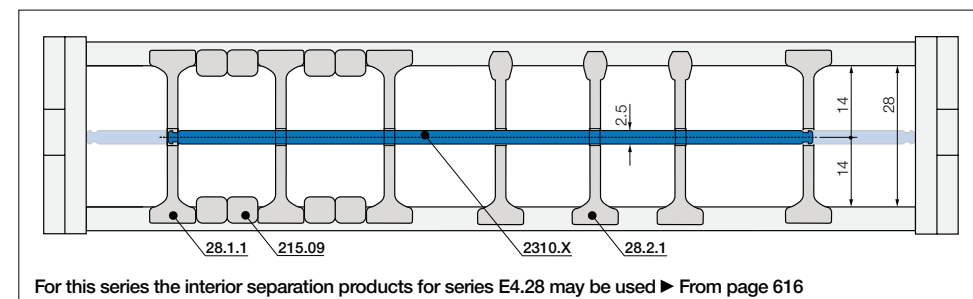

AR = Outer radius e-chain®
 IR = Inner radius e-chain®
 R = Bend radius e-chain®

X_i = Inner machine limit
 X_e = Outer machine limit
 A1 = Intermediate link position

H = Nominal clearance height
 K = Add-on for bend radius
 T = Pitch

Series TC32 | Crossbars removable along the inner and outer radius

AR	Bi	Ba	X ₂	X ₁	R 100 [mm]	R 125 [mm]	R 150 [mm]	R 175 [mm]	R 200 [mm]	R 250 [mm]	TC32
[mm]	[mm]	[mm]	[mm]	[mm]	TC32 ...	TC32 ...	TC32 ...	TC32 ...	TC32 ...	TC32 ...	[kg/m]
400	87.5	108.5	480	270	087.100/400	087.125/400	087.150/400	087.175/400	087.200/400	087.250/400	≈ 1.82
400	100	121	480	250	-	-	10.150/400	10.175/400	10.200/400	10.250/400	≈ 1.90
400	108	129	480	250	-	-	-	11.175/400	11.200/400	11.250/400	≈ 1.95
400	125	146	480	220	-	-	-	12.175/400	12.200/400	12.250/400	≈ 2.05
400	137.5	158.5	480	210	-	-	-	-	-	137.250/400	≈ 2.13
400	150	171	480	200	-	-	-	-	-	15.250/400	≈ 2.21
500	100	121	580	350	10.100/500	10.125/500	10.150/500	10.175/500	10.200/500	10.250/500	≈ 1.90
500	108	129	580	350	-	11.125/500	11.150/500	11.175/500	11.200/500	11.250/500	≈ 1.95
500	125	146	580	320	-	12.125/500	12.150/500	12.175/500	12.200/500	12.250/500	≈ 2.05
500	137.5	158.5	580	310	-	-	137.150/500	137.175/500	137.200/500	137.250/500	≈ 2.13
500	150	171	580	300	-	-	15.150/500	15.175/500	15.200/500	15.250/500	≈ 2.21
600	108	129	680	450	11.100/600	11.125/600	11.150/600	-	-	-	≈ 1.95
600	125	146	680	420	-	12.125/600	12.150/600	12.175/600	12.200/600	12.250/600	≈ 2.05
600	137.5	158.5	680	410	-	137.125/600	137.150/600	137.175/600	137.200/600	137.250/600	≈ 2.13
600	150	171	680	400	-	-	15.150/600	15.175/600	15.200/600	15.250/600	≈ 2.21

R	100	125	150	175	200	250	Pitch [mm/link]	56
H *°	254	304	354	404	454	554	Links/m	18
K	465	550	620	700	780	940	corresponds to [mm]	1,008



twisterchain 2nd generation from igus® - successfully tested for over 1 million cycles in the igus® laboratory

Dimension A1 dependent on outer radius AR

AR	R 100	R 125	R 150	R 175	R 200	R 250
[mm]	A1 [mm]	A1 [mm]	A1 [mm]	A1 [mm]	A1 [mm]	A1 [mm]
400	51	51	52	53	53	58
500	65	65	66	67	69	71
600	79	80	81	81	82	85

Dimension A1 always with tolerance of ± 2.5mm

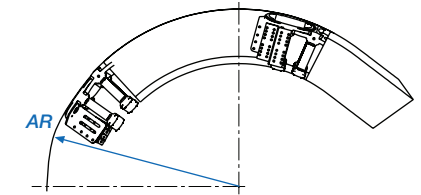

Note: Outer radius AR (see drawing) determines dimension A1!

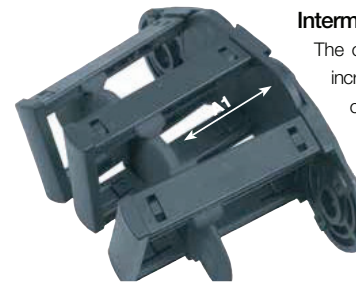

Intermediate link

The cable-friendly intermediate link increases the strength and stability of twisterchain many times over. It also serves as interior separation, dividing the filling space into two chambers. Outer radius AR determines dimension A1.

Dimensions

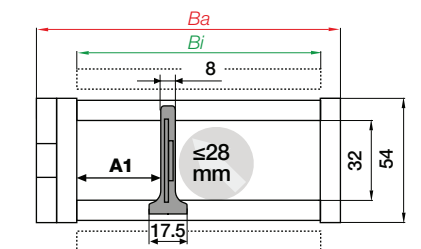

Serie TC32 | Additional parameters dependent on outer radius AR

AR	Max. fill weight α 0° - 180° [kg]	Max. fill weight α 180° - 360° [kg]	Max. V [m/s]	Max. a [m/s ²]
400	4.0	2.0	1.0	2.0
500	4.0	2.0	1.0	2.0
600	4.0	2.0	1.0	2.0

Series TC32 | Interior separation

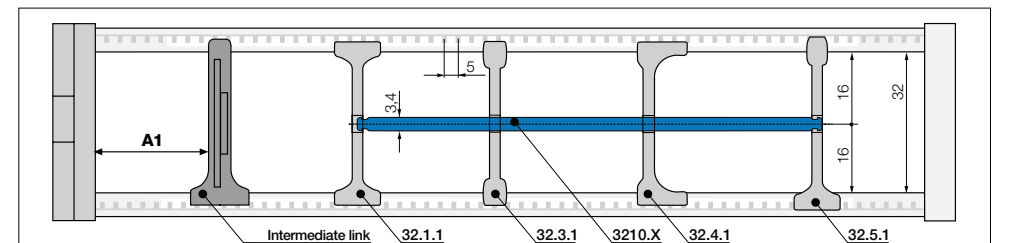

For this series the interior separation products for series E4.32 may be used ▶ From page 616

- i** AR = Outer radius e-chain°
- IR = Inner radius e-chain°
- R = Bend radius e-chain°
- X₁ = Inner machine limit
- X₂ = Outer machine limit
- A1 = Intermediate link position
- H = Nominal clearance height
- K = Add-on for bend radius
- T = Pitch



Series TC56 | Crossbars removable along the inner and outer radius

AR	Bi	Ba	X ₂	X ₁	R 150 [mm]	R 200 [mm]	R 250 [mm]	R 300 [mm]	R 400 [mm]	TC56
[mm]	[mm]	[mm]	[mm]	[mm]	TC56 ...	TC56 ...	TC56 ...	TC56 ...	TC56 ...	[kg/m]
650	125	155	730	470	12.150/650	12.200/650	12.250/650	12.300/650	-	≈ 3.45
650	137.5	168	730	460	-	13.200/650	13.250/650	13.300/650	13.400/650	≈ 3.54
650	150	180	730	450	-	-	15.250/650	15.300/650	15.400/650	≈ 3.62
650	162.5	193	730	440	-	-	16.250/650	16.300/650	16.400/650	≈ 3.70
650	175	205	730	430	-	-	-	17.300/650	17.400/650	≈ 3.78
650	187.5	218	730	420	-	-	-	18.300/650	18.400/650	≈ 3.87
650	200	230	730	400	-	-	-	-	20.400/650	≈ 3.95
750	137.5	168	830	560	13.150/750	13.200/750	13.250/750	13.300/750	-	≈ 3.54
750	150	180	830	550	-	15.200/750	15.250/750	15.300/750	15.400/750	≈ 3.62
750	162.5	193	830	540	-	16.200/750	16.250/750	16.300/750	16.400/750	≈ 3.70
750	175	205	830	530	-	-	17.250/750	17.300/750	17.400/750	≈ 3.78
750	187.5	218	830	520	-	-	18.250/750	18.300/750	18.400/750	≈ 3.87
750	200	230	830	500	-	-	20.250/750	20.300/750	20.400/750	≈ 3.95
850	150	180	930	650	15.150/850	15.200/850	15.250/850	15.300/850	15.400/850	≈ 3.62
850	162.5	193	930	640	16.150/850	16.200/850	16.250/850	16.300/850	16.400/850	≈ 3.70
850	175	205	930	630	17.150/850	17.200/850	17.250/850	17.300/850	17.400/850	≈ 3.78
850	187.5	218	930	620	-	18.200/850	18.250/850	18.300/850	18.400/850	≈ 3.87
850	200	230	930	600	-	-	20.250/850	20.300/850	20.400/850	≈ 3.95

R	150	200	250	300	400	Pitch [mm/link]	91
H ₊₂₅	384	484	584	684	884	Links/m	11
K	750	900	1,050	1,225	1,450	corresponds to [mm]	1,001



twisterchain in a guide trough type O1 for rotary movement on an articulated robot - long service life and robust: tested successfully for more than 1,000,000 cycles



Dimension A1 dependent on outer radius AR

AR	R 150	R 200	R 250	R 300	R 400
[mm]	A1 [mm]	A1 [mm]	A1 [mm]	A1 [mm]	A1 [mm]
650	83	85	88	90	97
750	98	101	102	103	110
850	113	116	117	118	124

Dimension A1 always with tolerance of ± 2.5mm

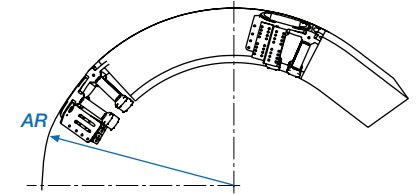

Note: Outer radius AR (see drawing) determines dimension A1!



Intermediate link

The cable-friendly intermediate link increases the strength and stability of twisterchain many times over. It also serves as interior separation, dividing the filling space into two chambers. Outer radius AR determines dimension A1.

Dimensions

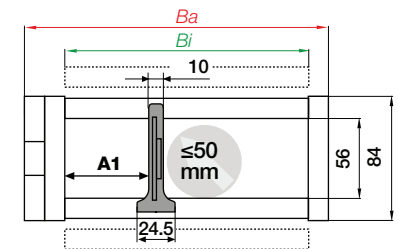

Series TC56 | Additional parameters dependent on outer radius AR

AR	Max. fill weight α 0° - 180° [kg]	Max. fill weight α 180° - 360° [kg]	Max. V [m/s]	Max. a [m/s ²]
650	8.0	5.0	1.0	2.0
750	8.0	5.0	1.0	2.0
850	8.0	5.0	1.0	2.0

Series TC56 | Interior separation

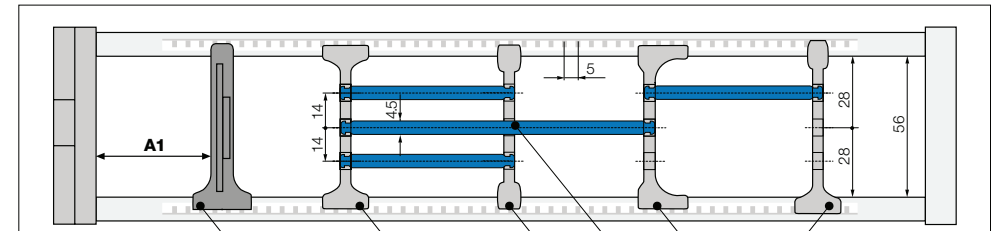

For this series the interior separation products for series E4.56 may be used ▶ From page 616

- i** AR = Outer radius e-chain°
- IR = Inner radius e-chain°
- R = Bend radius e-chain°
- X₁ = Inner machine limit
- X₂ = Outer machine limit
- A1 = Intermediate link position
- H = Nominal clearance height
- K = Add-on for bend radius
- T = Pitch

Steel mounting bracket for twisterchain (2nd generation)

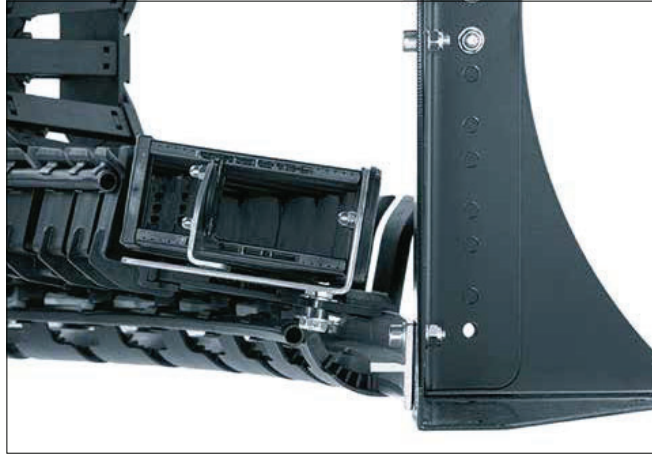

Position 1 Position 2

Important note: twisterchain e-chains® must always start and end on an outer side link (odd number of links).

- One part for all e-chain® widths
- Electrically conductive
- Universal installation
- Material: AISI 304 stainless steel

Steel, one-piece for twisterchain (2nd generation) | Recommended for unsupported and rotary applications

For series	Part No. full set	Part No. position 1	Part No. position 2
TC32	TC3200.34.VS.E	TC3200.30.VS.E	TC3200.40.VS.E
TC42	TC4200.34.VS.E	TC4200.30.VS.E	TC4200.40.VS.E
TC56	TC5600.34.VS.E	TC5600.30.VS.E	TC5600.40.VS.E

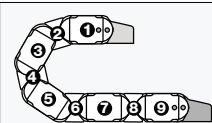

Important note: twisterchain e-chains® must always start and end on an outer side link (odd number of links). An outer side link should always be the first link at the moving end.

TC3200.34.VS.E Order example

- Stainless steel (standard)
- Standard: bolted
- Full set
- Series

Steel mounting bracket for twisterchain classic (1st generation)

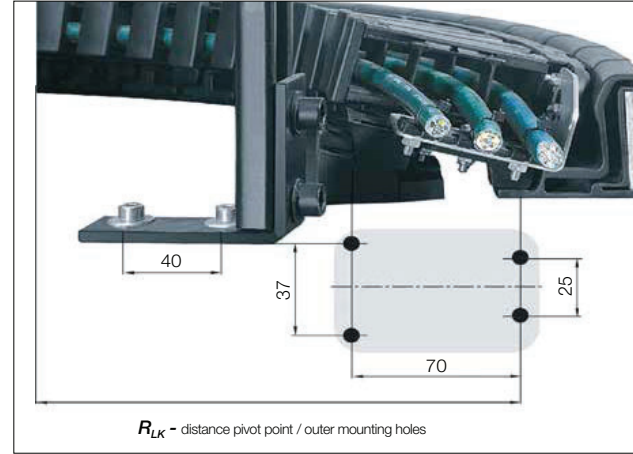

Position 1 Position 2

Important note: twisterchain e-chains® must always start and end on an outer side link (odd number of links).

- One part for all e-chain® widths
- Electrically conductive
- Universal installation
- Material: AISI 304 stainless steel

Steel, one-piece for twisterchain classic (1st generation) | Recommended for unsupported and rotary applications

For series	Part No. full set	Part No. position 1	Part No. position 2
2208	22080.34.VS.E	22080.30.VS.E	22080.40.VS.E

The guide trough is attached to the fixed end of the twisterchain classic based on the drill pattern shown in the diagram.
The following bolted connections are permitted: ● Plain holes: 4 x Ø 6.6 - 7mm ● Mounting only with bolts: 4 x bolts M6

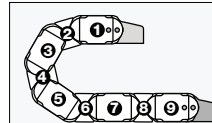

Important note: twisterchain e-chains® must always start and end on an outer side link (odd number of links). An outer side link should always be the first link at the moving end.

22080.34.VS.E Order example

- Stainless steel (standard)
- Standard: bolted
- Full set
- Series

Save installation time and cost - better guidance for circular movement - increase service life!

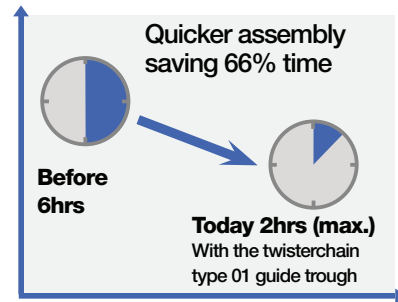
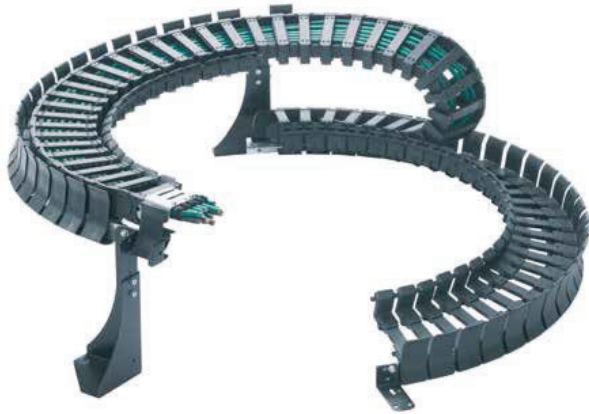

i Guide trough type 02 for series 2208 ▶ From page 1106

With the twisterchain trough type 01, complex adjustment work is reduced and so assembly time is reduced from 6 hours to 2 hours. It also reduces noise, whilst travel speed and service life can be increased, thanks to its nearly all-plastic design. Available for all twisterchains from the new and original product range.

- Suitable for high dynamics, because of the full guidance of the upper run
- Much smoother and quieter motion in the trough due to continuous guidance of the upper run
- Upper run guided in the polymer trough over the full length
- Preassembled delivery possible
- Easy adjustment, alignment and handling
- Assembly time reduced from 6 hours to 2 hours

twisterchain type 01 guide trough options

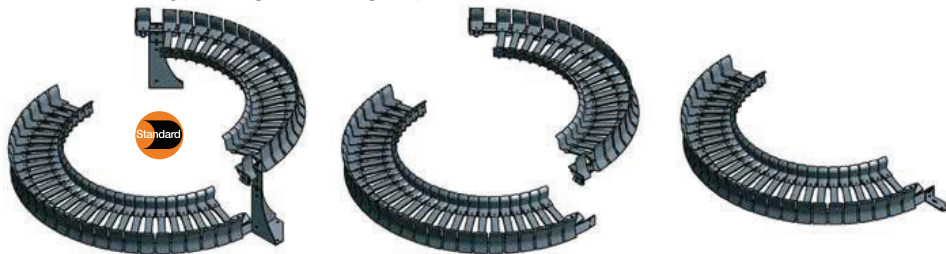

9XXX.31
Complete trough
(with base support, height adjustment and attachment angle brackets)

9XXX.32
Upper and lower run trough
(without floor support and height adjustment)
Special option: customer supplies base supports

9XXX.30
Lower run trough
(with mounting angle brackets)
Special option: customer builds upper run trough

Product range | twisterchain guide trough type 01

Part No. series	Outer radius AR (mm)	Angle of rotation min.-max. α	Part No.		
			complete trough	upper/lower run trough	lower run trough
TC32 / TC42	400	0 - 90°	9XXX.31.90 .400/Bi.R	9XXX.32.90 .400/Bi.R	9XXX.30.90 .400/Bi.R
		90° - 180°	9XXX.31.180.400/Bi.R	9XXX.32.180.400/Bi.R	9XXX.30.180.400/Bi.R
		180° - 270°	9XXX.31.270.400/Bi.R	9XXX.32.270.400/Bi.R	9XXX.30.270.400/Bi.R
	500	0 - 90°	9XXX.31.90 .500/Bi.R	9XXX.32.90 .500/Bi.R	9XXX.30.90 .500/Bi.R
		90° - 180°	9XXX.31.180.500/Bi.R	9XXX.32.180.500/Bi.R	9XXX.30.180.500/Bi.R
		180° - 270°	9XXX.31.270.500/Bi.R	9XXX.32.270.500/Bi.R	9XXX.30.270.500/Bi.R
	600	0 - 90°	9XXX.31.90 .600/Bi.R	9XXX.32.90 .600/Bi.R	9XXX.30.90 .600/Bi.R
		90° - 180°	9XXX.31.180.600/Bi.R	9XXX.32.180.600/Bi.R	9XXX.30.180.600/Bi.R
		180° - 270°	9XXX.31.270.600/Bi.R	9XXX.32.270.600/Bi.R	9XXX.30.270.600/Bi.R
TC42 / TC56	650	0 - 90°	9XXX.31.90 .650/Bi.R	9XXX.32.90 .650/Bi.R	9XXX.30.90 .650/Bi.R
		90° - 180°	9XXX.31.180.650/Bi.R	9XXX.32.180.650/Bi.R	9XXX.30.180.650/Bi.R
		180° - 270°	9XXX.31.270.650/Bi.R	9XXX.32.270.650/Bi.R	9XXX.30.270.650/Bi.R
	750	0 - 90°	9XXX.31.90 .750/Bi.R	9XXX.32.90 .750/Bi.R	9XXX.30.90 .750/Bi.R
		90° - 180°	9XXX.31.180.750/Bi.R	9XXX.32.180.750/Bi.R	9XXX.30.180.750/Bi.R
		180° - 270°	9XXX.31.270.750/Bi.R	9XXX.32.270.750/Bi.R	9XXX.30.270.750/Bi.R
	850	0 - 90°	9XXX.31.90 .850/Bi.R	9XXX.32.90 .850/Bi.R	9XXX.30.90 .850/Bi.R
		90° - 180°	9XXX.31.180.850/Bi.R	9XXX.32.180.850/Bi.R	9XXX.30.180.850/Bi.R
		180° - 270°	9XXX.31.270.850/Bi.R	9XXX.32.270.850/Bi.R	9XXX.30.270.850/Bi.R
		270° - 360°	9XXX.31.360.850/Bi.R	9XXX.32.360.850/Bi.R	9XXX.30.360.850/Bi.R

Complete part No. **9XXX** with required series (TC32, TC42, TC56), value **Bi** and required bend radius **R** ▶ **9TC32.31.180.600/06.250**
For series 2208 please use guide troughs type 02 ▶ Page 1106

9TC32.31.180.600/12.250

9XXXX.31.180.600/Bi.R

i Order key
Guide trough type 01

- R** - Bend radius, please add required value
- Bi** - width index, please add required value
- Outer radius e-chain®
- Angle of rotation of application (90°, 180°, 270°, 360°)
- Trough version
- Guide trough of selected series

More order examples

Complete trough	Part No. 9TC32.31.180.600/12.250
Lower run trough only	Part No. 9TC32.30.180.600/12.250
Upper and lower run trough without base support	Part No. 9TC32.32.180.600/12.250

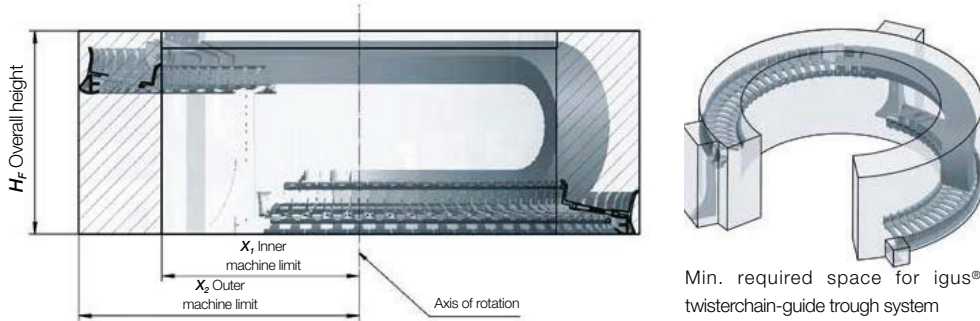

Min. required space for igus® twisterchain-guide trough system

Installation dimensions | X_1 inner machine limit and X_2 outer machine limit

AR [mm]	X_2 [mm]	X_1 , depending on B_i [mm]											
		87.5	100	108	125	137.5	150	162.5	168	175	187.5	200	
TC32		87.5	100	108	125	137.5	150						
400	480	270	250	250	220	210	200						
500	580	-	350	350	320	310	300						
600	680	-	-	450	420	410	400						
TC42		87.5	100	108	125	137.5	150	162.5	168	175	187.5	200	
400	480	270	250	250	220	210	200	190	190	180	-	-	
500	580	-	350	350	320	310	300	290	290	280	280	250	
600	680	-	-	450	420	410	400	390	390	380	380	350	
650	730	-	-	-	470	460	450	440	440	430	420	400	
750	830	-	-	-	-	560	550	540	540	530	520	500	
850	930	-	-	-	-	-	650	640	640	630	620	600	
TC56		-	-	-	125	137.5	150	162.5	-	175	187	200	
650	730	-	-	-	470	460	450	440	-	430	420	400	
750	830	-	-	-	-	560	550	540	-	530	520	500	
850	930	-	-	-	-	650	640	-	630	620	600		

For series 2208 please use guide troughs type 02 ▶ Page 1106

Construction height | H_F depending on bend radius of twisterchain guide trough

Part No. series	R [mm]	100	125	150	175	200	250	300	400
TC32		370	420	470	520	570	670	-	-
TC42		380	430	480	530	580	680	-	-
TC56		-	-	500	-	600	700	800	1,000

Angle of rotation for 360° | W_2 angle of upper run twisterchain guide trough

Part No. series	AR [mm]	R [mm]	100	125	150	175	200	250	300	400
TC32/TC42	400		90°	90°	90°	90°	90°	90°	90°	90°
TC32/TC42	500		90°	90°	90°	90°	90°	90°	90°	90°
TC32/TC42	600		135°	135°	135°	135°	90°	90°	90°	90°
TC42/TC56	650		135°	135°	135°	135°	90°	90°	90°	90°
TC42/TC56	750		135°	135°	135°	135°	135°	135°	90°	90°
TC42/TC56	850		135°	135°	135°	135°	135°	135°	135°	135°

Support for the upper run as of 180° rotation angle

Angle of rotation | W_1 | W_{total}

Angle of rotation of system	Angle of lower run
W_{ges} 90°	W_1 45°
180°	90°
270°	135°
360°	180°

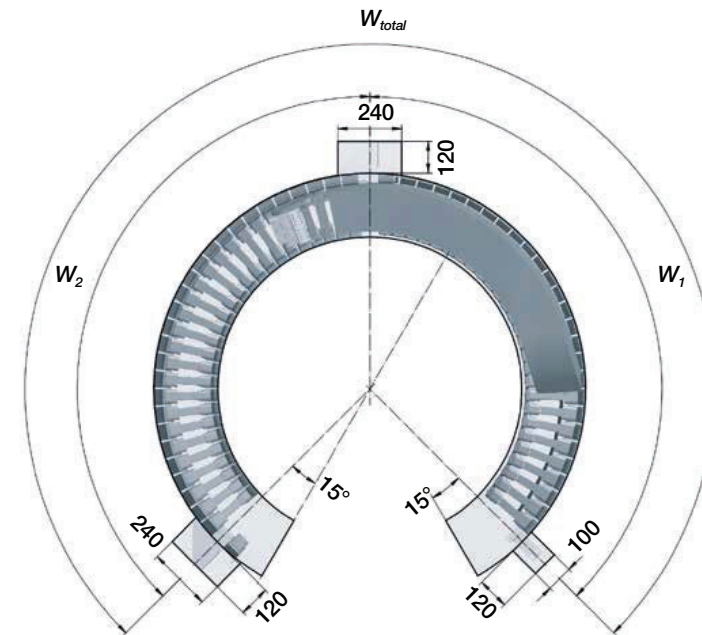

i AR = Outer radius e-chain®
 IR = Inner radius e-chain®
 R = Bend radius e-chain®
 X_1 = Inner machine limit
 X_2 = Outer machine limit
 H_F = Total trough height
 H_F = e-chain® height incl. 50mm clearance
 H = e-chain® height
 K = Add-on for bend radius
 W_1 = Angle of upper run
 W_2 = Angle of lower run
 W_{total} = Angle of rotation of system

Guide trough type 02 for twisterchain classic (1st generation) series 2208

- Support for the upper run and guidance of twisterchain classic series 2208
- Angle of rotation up to 360° possible, 400° upon request
- The modular design of the guide trough makes it possible to connect a large number of e-chains® radii, circle and bend radii by using the same trough sections
- If the e-chain® radius changes, the trough can simply be adapted without purchasing a completely new trough
- The specified part number shown below includes the complete trough system



Product range | Guide trough type 02 for twisterchain classic (1st generation)

Part No. series	Outer radius AR [mm]	Angle of rotation min.-max. α	Part No. Guide trough type 02	Part No. Guide trough with bottom support	Number of supports
2208	300	45° - 100°	92208.4.45.300/ Bi.R	not necessary	-
	300	>100° - 180°	92208.4.90.300/ Bi.R	not necessary	-
	300	>180° - 270°	92208.4.135.300/ Bi.R*	92208.5.135.300/ Bi.R	1
	300	>270° - 360°	92208.4.180.300/ Bi.R**	92208.5.180.300/ Bi.R	2

* These troughs feature one support for the upper run / ** These troughs feature two supports for the upper run

Complete Part No. with the required Bi and bend radius R e.g. 92208.5.180.600/112.150

92208.5.180.600/112.150



Order key Guide trough type 02

R - Bend radius, please add required value

Bi - width index, please add required value

Outer radius e-chain®

Trough angle (Standard 180°, 135°, 90°, 45°)

Trough version (.5. with and .4. without bottom support)

Guide trough - series 2208

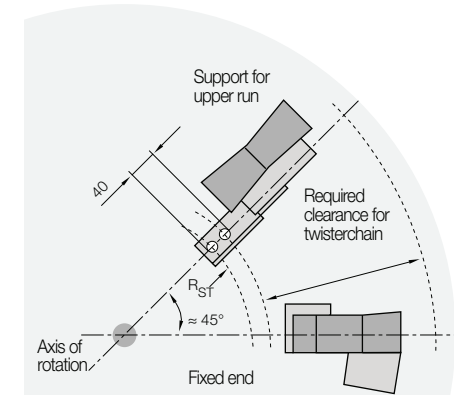
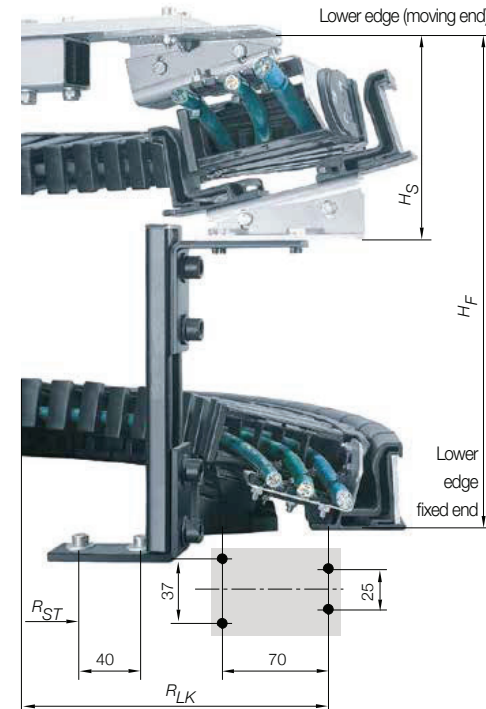

Mounting position for one support

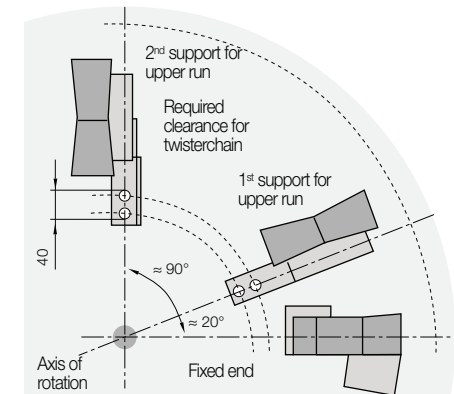

Mounting position for two supports

The guide trough must be mounted at the fixed end of the twisterchain using the drilling template shown. The following screw connections are allowed:

- Bore hole: 4 x Ø 6.6 - 7mm
- Mounting only with bolts: 4 x bolt M6

Installation dimensions | Guide troughs type 02 (1st generation)

Part No. series	R_{LK} [mm]	H_s [mm]	Part No. Guide trough	R_{ST} [mm]	R [mm]	055	063	075	100	125	150
2208 ...	265	130	92208 ...	145		195	211	235	285	335	385