

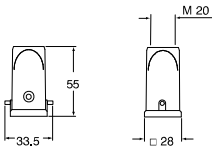

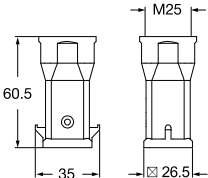



CK-MK Plastic Enclosures

Size 21.21

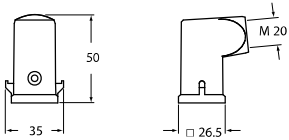

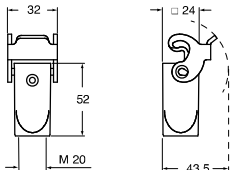

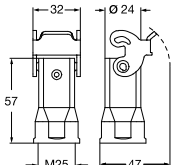









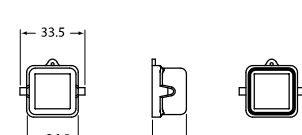
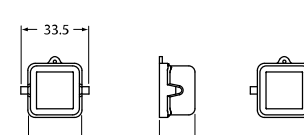
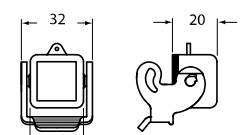
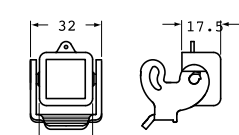









CK 03 I	CK 03 IA	MK IAP20
 	 	 

MK V20	MK V25	MK VA20
 	 	 

MK VG20	MK V G25
 	 

CK-MK Plastic Enclosures

Size 21.21

CK 03 C for female inserts	CK 03 CA for male inserts	CK 03 CX for female inserts	CK 03 CXA for male inserts
			
			
CKR 65		CKR 65 D	
gasket & screw kit for IP66/IP67/IP69		gasket & screw kit for IP66/IP67/IP69 only for CD07/08 inserts	
			
Male Inserts		Female Inserts	
CKM 03 3pin & Earth 10 amp 250 volt		CKF 03 3 pin & Earth 10 amp 250 volt	
CKM 04 4pin & Earth 10 amp 250 volt		CKF 04 4 pin & Earth 10 amp 250 volt	
CDM 07 7pin & Earth 10 amp 250 volt (crimp)		CDF 07 7pin & Earth 10 amp 250 volt (crimp)	
CDM 08 8pin 10 amp 50 volt (crimp)		CDF 08 8 pin 10 amp 50 volt (crimp)	
CQM 05 5 pin & Earth 16 amp 400 volt (crimp)		CQF 05 5 pin & Earth 16 amp 400 volt (crimp)	
CQM 12 12 Pin 10 amp 400 volt (crimp)		CQF 12 12 Pin 10 amp 400 volt (crimp)	
CQM 21 21 Pin 6.5 amp 50 volt (crimp)		CQF 21 21 Pin 6.5 amp 50 volt (crimp)	
CQ4M 02 2 Pin 40 amp 400 volt (crimp)		CQ4M 02 2 Pin 40 amp 400 volt (crimp)	

All dimensions in mm. For crimp pins refer to page 354.