

Inserts with incorporated terminal block for multipole connectors (10A max versions)

CT series multipole connectors (with incorporated 45° terminal block) are recommended for greater cost-saving and safety for use on machines and command and control panels.

For control panel mounting, bulkhead housings must be used.

CT series inserts (10A max versions) are supplied in the plug or socket versions and must be mounted with insertion from the rear of the enclosure (Figures 1 and 2), as the space occupied by the terminal block does not allow for the passage of the insert and insertion from the front of the enclosure.

As an alternative to the traditional terminal blocks, the inserts can be mounted inside the control panels on DIN EN 60715 rails (Figure 5) using suitable accessories providing the added advantage of easy sectioning.

The special structure of CT inserts provides all the conductor connections on the same side, achieving easier wiring and a complete view of the work area.

The 45° terminal block has also slots for housing the identification wire markers of each contact.

Wire markers of different manufacturers may be used such as: Cabur, Grafoplast, Modernotecnica, Phoenix Contact, Siemens, Wago, Weidmüller.

CT series is available in the versions "left-hand" and "right-hand" for mounting on the left (Figure 3) or on the right (Figure 4) of the control panel walls.

This characteristic is determined by the position of contact "1" and the protective earth terminal in the upper part of the insert terminal block for both left and right mounting.

The installation of inserts on DIN rails (Figure 5) inside the control panels is usually made to ease the wiring in sectionable parts.

In this case the degree of protection for coupled connectors is IP20 (in accordance with EN 60529).

This type of mounting requires supports (CT APE) suitable for mounting on DIN EN 60715 rail. to be provided to the inserts.

In addition, CRBF (female) and CRBM (male) coupling screws instead of normal screws are recommended for fixing the inserts to the enclosures (Figure 5) in order to guarantee a stable and safe coupling between the CT and CTS inserts installed on the DIN rails and corresponding mating CD inserts.

Figures 1 and 2 (rear mounting)

The insert is inserted into the bulkhead housing with pre-wired conductors connected at the opposite end

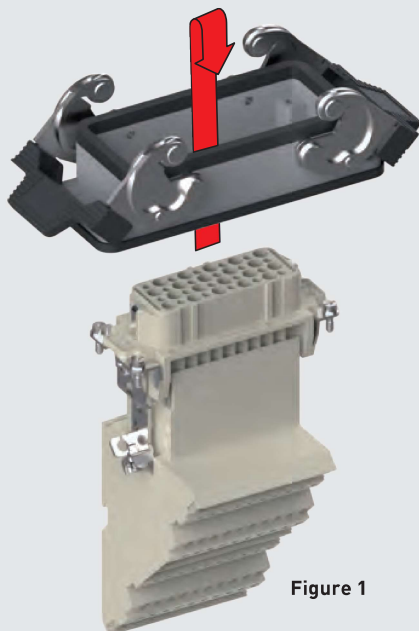

Figure 1

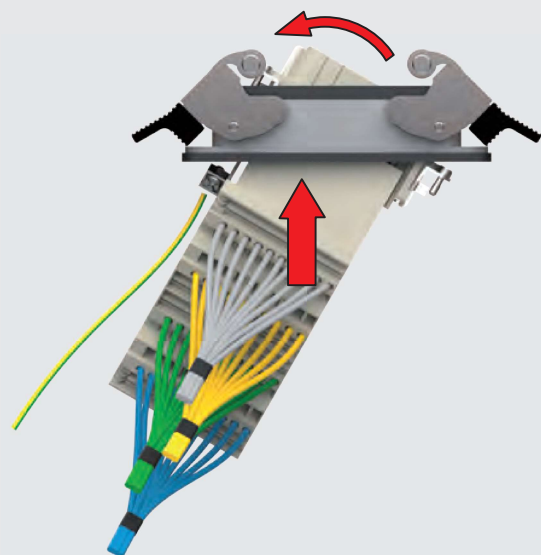
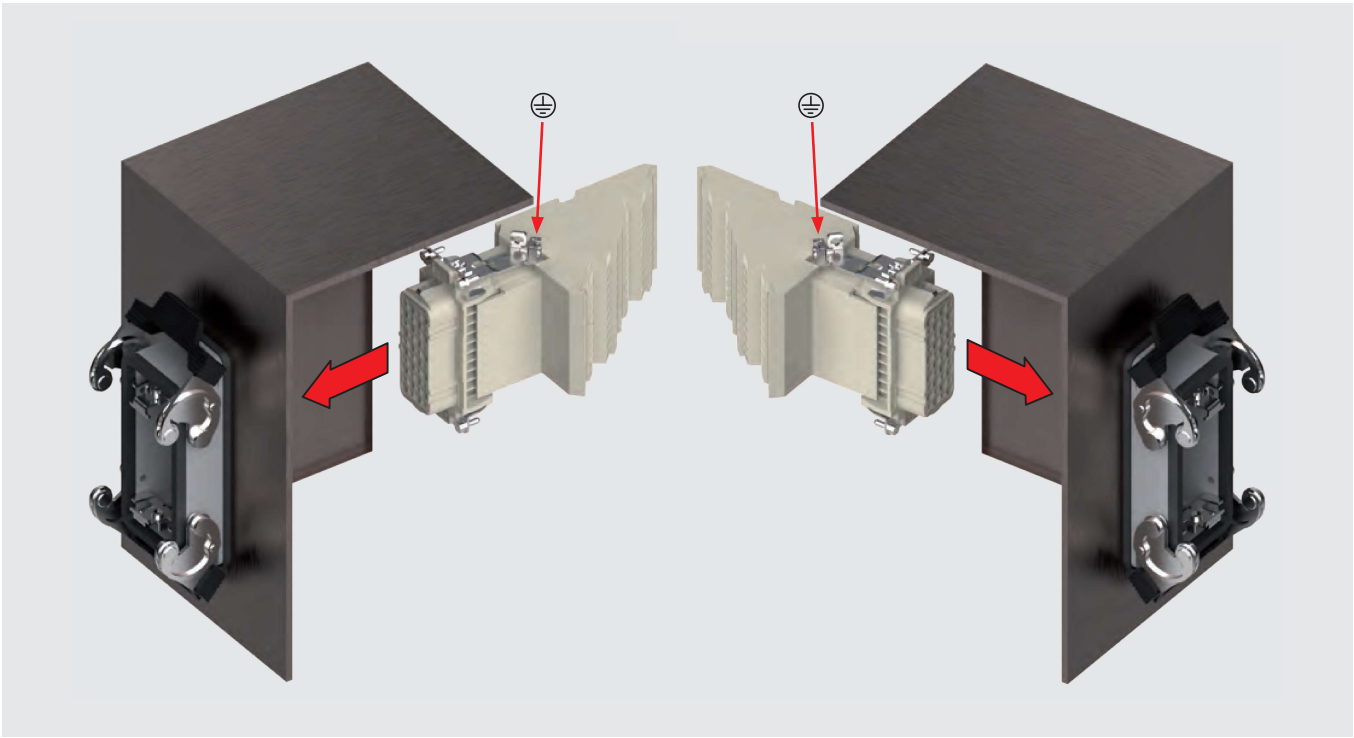

Figure 2

Figure 3 (left mounting)

Figure 4 (right mounting)



CT - CTS

Figure 5 (mounting on DIN rail)

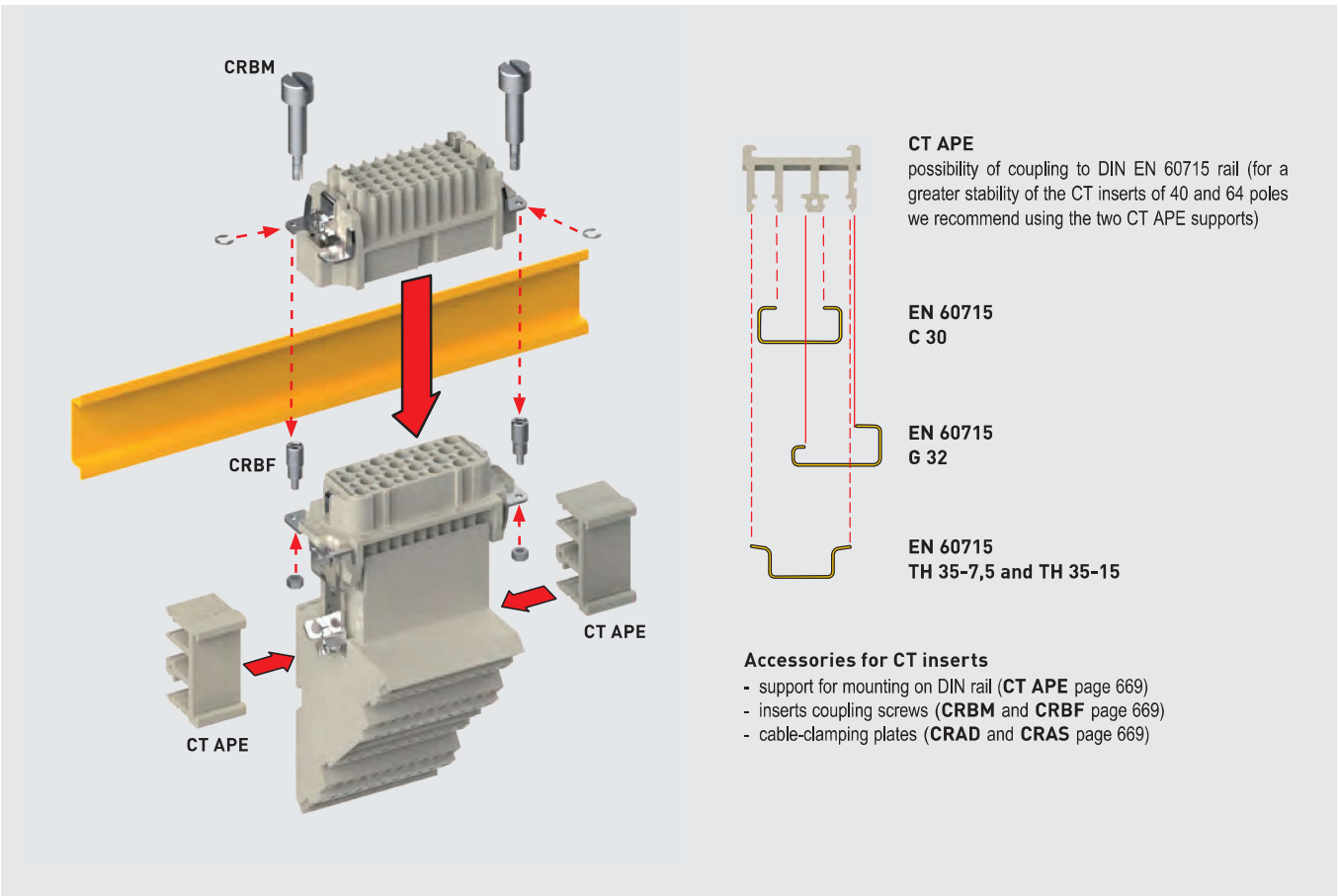

CT - CTS 40 poles + ⊕ 10A - 250V

enclosures *):
size "77.27"

	page:
C-TYPE IP65 or IP66/IP69	402
C7 IP67, two levers	439 - 440
V-TYPE IP65 or IP66/IP69, single lever	454 - 455
W-TYPE for aggressive environments	523
E-Xtreme® corrosion proof	534, 544
EMC	580
Central lever	609
LS-TYPE	622

*) only bulkhead mounted housings

- can be mated with CD inserts
- rear-mounted inserts

terminal block inserts
screw terminal connection

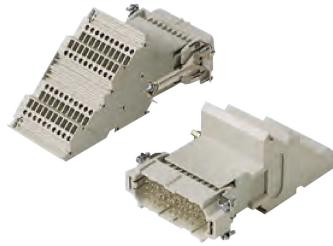

Q SILVER PLATED CONTACTS

terminal block inserts
spring terminal connection

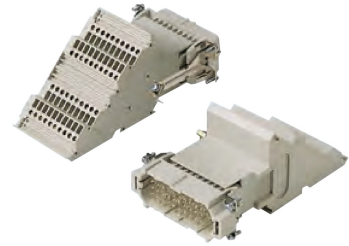

Q SILVER PLATED CONTACTS

CT - CTS

description	part No.		part No.	
	left	right	left	right
mounting side (see page 155) female inserts with female contacts ¹⁾ male inserts with male contacts ¹⁾	CTF 40 L CTM 40 L	CTF 40 R CTM 40 R	CTSF 40 L CTSM 40 L	CTSF 40 R CTSM 40 R
mounting side (see page 155) female inserts with female contacts male inserts with male contacts				

1) for non-prepared conductors

- characteristics according to EN 61984:

10A 250V 4kV 3
10A 230/400V 4kV 2

- certified (CT)
- certified (CTS)

- rated voltage according to UL/CSA: 600V
- insulation resistance: ≥ 10 GΩ
- ambient temperature limit: -40 °C ... +125 °C
- made of self-extinguishing thermoplastic resin UL 94V-0
- mechanical life: ≥ 500 cycles
- contact resistance: ≤ 4 mΩ
- for max. current load see the connector inserts derating diagram below; for more information see page 28

female inserts (CTF and CTSF)

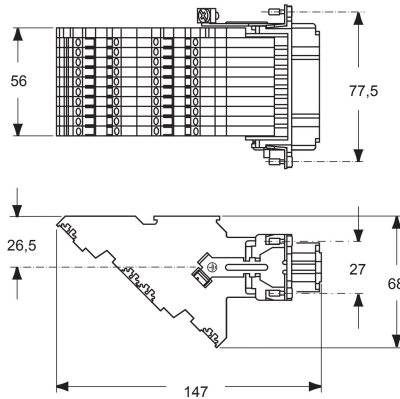

contacts side (front view)

female inserts (CTF and CTSF)

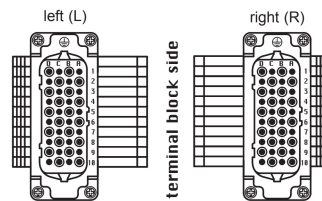

male inserts (CTM and CTSM)

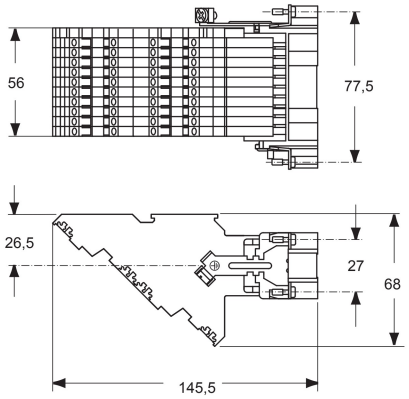

male inserts (CTM and CTSM)

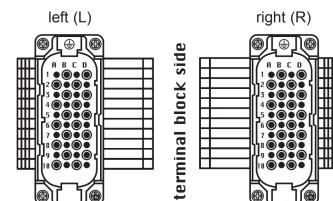

CT and CTS 40 poles connector inserts
Maximum current load derating diagram

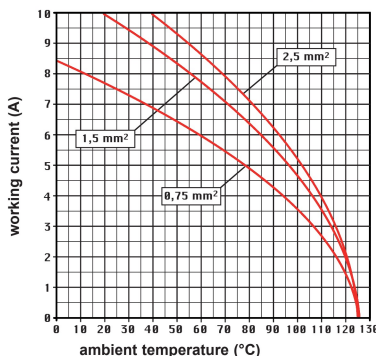

- CT inserts with plate, for section conductors: 0,75 - 2,5 mm² - AWG 18 - 14
- conductors stripping length: 12 mm
- terminal screw torque: 0,4 Nm (3,54 lb.in), for more information see page 20 and 21

- CTS spring inserts for section conductors: effective sections for non-prepared conductors 0,14 - 2,5 mm² - AWG 26 - 14
- effective sections for prepared conductors 0,14 - 1 mm² - AWG 26 - 18
- conductors stripping length: 9...11 mm

Connection technology with spring terminal

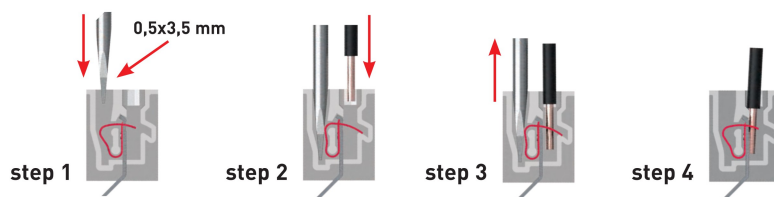

CT - CTS 64 poles + ⊕ 10A - 250V

enclosures *):
size "104.27"

	page:
C-TYPE IP65 or IP66/IP69	412
C7 IP67, two levers	441 - 442
V-TYPE IP65 or IP66/IP69, single lever	459 - 460
W-TYPE for aggressive environments	524
E-Xtreme® corrosion proof	536, 545
EMC	581
Central lever	612
LS-TYPE	624

*) only bulkhead mounted housings

- can be mated with CD inserts
- rear-mounted inserts

terminal block inserts screw terminal connection



Q SILVER PLATED CONTACTS

terminal block inserts spring terminal connection



Q SILVER PLATED CONTACTS

description	part No.	part No.	part No.	part No.
mounting side (see page 155) female inserts with female contacts ¹⁾ male inserts with male contacts ¹⁾	left CTF 64 L CTM 64 L	right CTF 64 R CTM 64 R	left CTS F 64 L CTSM 64 L	right CTS F 64 R CTSM 64 R
mounting side (see page 155) female inserts with female contacts male inserts with male contacts				

¹⁾ for non-prepared conductors

- characteristics according to EN 61984:

10A 250V 4kV 3

10A 230/400V 4kV 2

- certified (CT)

- certified (CTS)

- rated voltage according to UL/CSA: 600V

- insulation resistance: ≥ 10 GΩ

- ambient temperature limit: -40 °C ... +125 °C

- made of self-extinguishing thermoplastic resin UL 94V-0

- mechanical life: ≥ 500 cycles

- contact resistance: ≤ 4 mΩ

- for max. current load see the connector inserts derating diagram below; for more information see page 28

female inserts (CTF and CTSF)

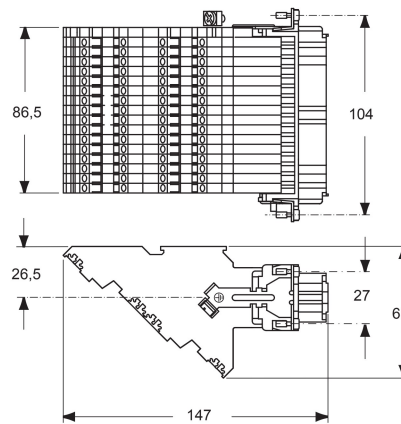

contacts side (front view)

female inserts (CTF and CTSF)

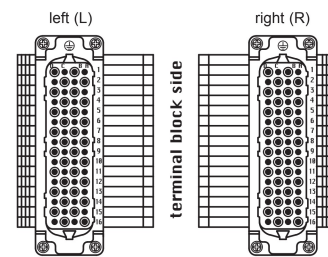

male inserts (CTM and CTSM)

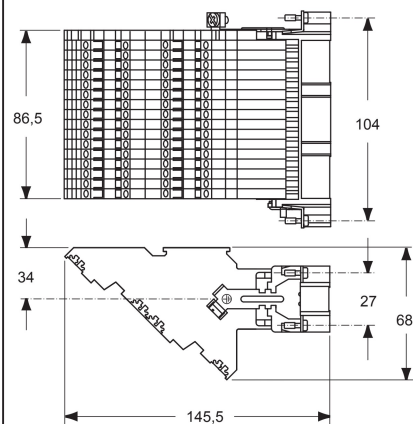

male inserts (CTM and CTSM)

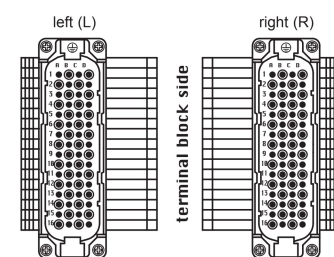

CT and CTS 64 poles connector inserts Maximum current load derating diagram

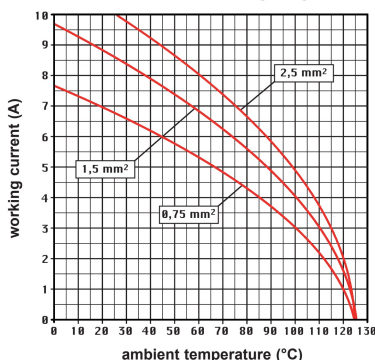

- CT inserts with plate, for section conductors: 0,75 - 2,5 mm² - AWG 18 - 14
- conductors stripping length: 12 mm
- terminal screw torque: 0,4 Nm (3,54 lb.in), for more information see page 20 and 21

- CTS spring inserts for section conductors: effective sections for non-prepared conductors 0,14 - 2,5 mm² - AWG 26 - 14
- effective sections for prepared conductors 0,14 - 1 mm² - AWG 26 - 18
- conductors stripping length: 9...11 mm

Connection technology with spring terminal

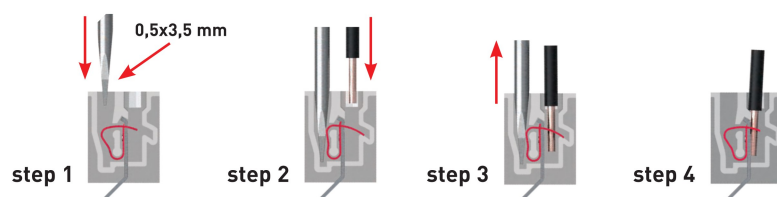

Inserts with incorporated terminal block for multipole connectors (16A max versions)

45° CT - CTSE series multipole connectors (with incorporated terminal block) are recommended for greater cost-saving and safety for use on machines and command and control panels.

The CT - CTSE series inserts (16A max versions) are supplied in the plug or socket versions and may be mounted with insertion from the front of the enclosure (**Figure 1** for all the polarities of the inserts) or with insertion from the rear of the enclosure (**Figure 2**, only for 16 and 24-pole inserts).

As an alternative to the traditional terminal blocks, the inserts can be mounted inside the control panels on DIN EN rails (**Figure 5**) using suitable accessories providing the added advantage of easy sectioning.

The special structure of the CT - CTSE inserts has all the conductor connections on the same side providing for easier wiring and a complete view of the work area.

The terminal block has also slots for housing the identification wire markers of each contact.

Wire markers of different manufacturers may be used such as: Cabur, Grafoplast, Modernotecnica, Phoenix Contact, Siemens, Wago, Weidmüller.

The CT - CTSE series is available in the versions "left" and "right" for mounting on the left (**Figure 3**) or on the right (**Figure 4**) of the control panel walls.

This characteristic is determined by the position of contact "1" and the ground terminal in the upper part of the insert terminal block for both left and right mounting.

The installation of inserts on DIN rails (**Figure 5**) inside the control panels is usually made to facilitate the wiring into sectionable parts.

In this case the degree of protection for coupled connectors is IP20 (in accordance with EN 60529).

This type of mounting requires supports (CT APE) suitable for mounting on DIN EN 60715 rails.

Furthermore, to ensure a stable and secure mating between the CT and CTSE inserts installed on DIN rails and counterparts CNE, CCE, CSH, CSS mating screws CRBF (female) and CRBM (male) are recommended, to replace the ordinary fastening screws to the enclosures (**Figure 5**).

Figure 1 (front mounting)

The insert is inserted into the bulkhead housing without wired conductors or with pre-wired conductors that are not connected at the opposite end.

Mounting for inserts of 06, 10, 16 and 24 poles

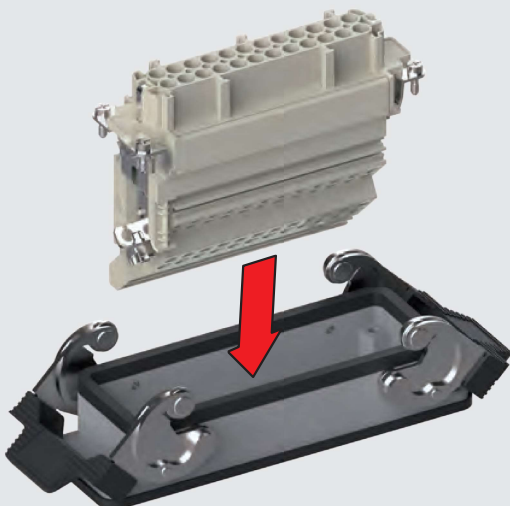

Figure 2 (rear mounting)

The insert is inserted into the bulkhead housing with pre-wired conductors connected at the opposite end.

Mounting for inserts of 16 and 24 poles

Except version T-TYPE

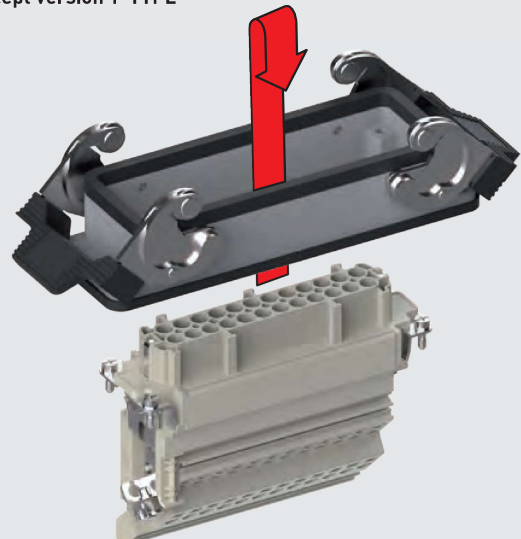
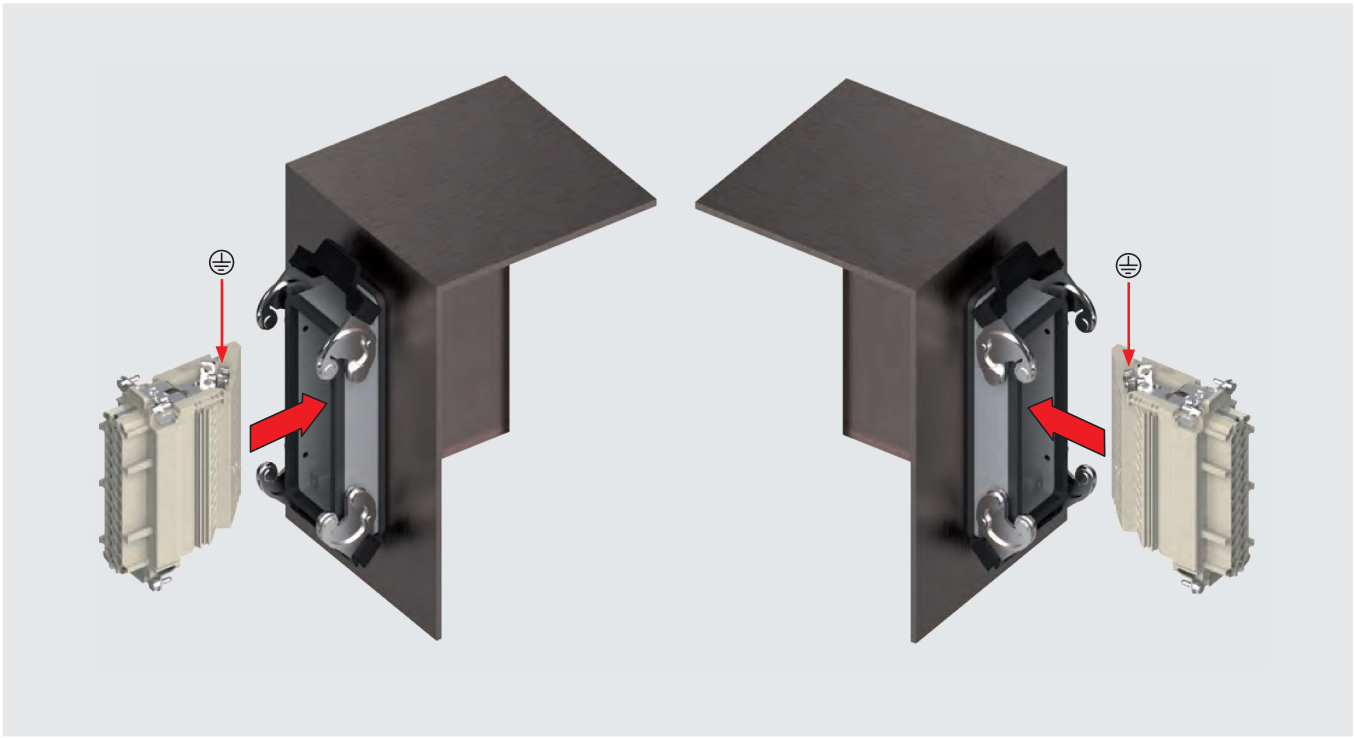

Figure 3 (left mounting)

Figure 4 (right mounting)



CT - CTSE

Figure 5 (mounting on DIN rail)

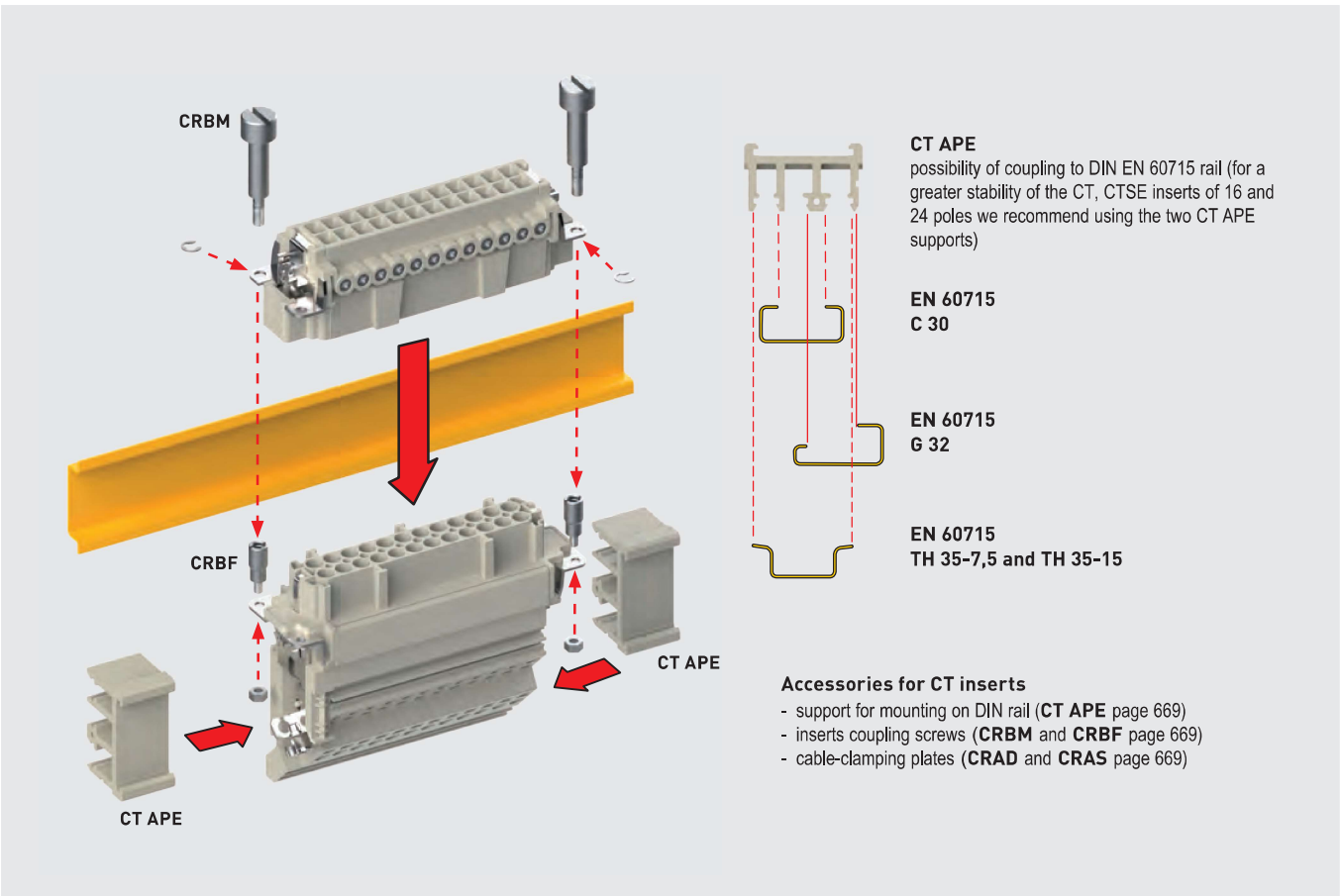

enclosures *):
size "44.27"

page:

C-TYPE IP65 or IP66/IP69	387
C7 IP67, single lever	436 - 437
V-TYPE IP65 or IP66/IP69, single lever	444 - 445
BIG hoods	466 - 467
T-TYPE IP65 insulating	480 - 481
T-TYPE / W IP66/IP69 insulating	489
HYGIENIC T-TYPE / H IP66/IP69	501
HYGIENIC T-TYPE / C IP66/IP69, -50 °C	506
W-TYPE for aggressive environments	521
E-Xtreme® corrosion proof	530, 542
EMC	578
Central lever	603
LS-TYPE	618

*) only bulkhead mounted housings and BIG hoods

- can be mated with CNE, CCE, CSS, CSH inserts
- inserts may be fitted from front of enclosure

terminal block inserts
screw terminal connection

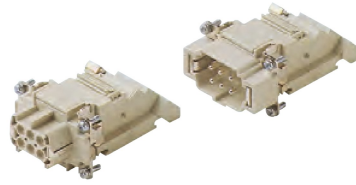

Q SILVER PLATED CONTACTS

terminal block inserts
spring terminal connection

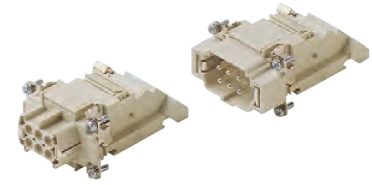

Q SILVER PLATED CONTACTS

description	part No.	part No.	part No.	part No.
mounting side (see page 159)				
female inserts with female contacts ¹⁾	left	right		
male inserts with male contacts ¹⁾	CTF 06 L	CTF 06 R		
	CTM 06 L	CTM 06 R		
mounting side (see page 159)				
female inserts with female contacts			left	right
male inserts with male contacts			CTSEF 06 L	CTSEF 06 R
			CTSEM 06 L	CTSEM 06 R

1) for non-prepared conductors

- characteristics according to EN 61984:
- 16A 230/400V 4kV 3 (CT)**
- 16A 400V 4kV 2 (CT)**
- 16A 500V 6kV 3 (CTSE)**
- 16A 400/690V 6kV 2 (CTSE)**

- certified (CT)

- certified (CTSE)

- rated voltage according to UL/CSA: 600V

- insulation resistance: ≥ 10 GΩ

- ambient temperature limit: -40 °C ... +125 °C

- made of self-extinguishing thermoplastic resin UL 94V-0

- mechanical life: ≥ 500 cycles

- contact resistance: ≤ 4 mΩ
- for max. current load see the connector inserts derating diagrams below; for more information see page 28

CT 06 poles connector inserts
Maximum current load derating diagram

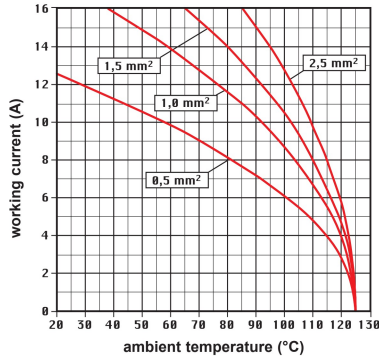

CTSE 06 poles connector inserts
Maximum current load derating diagram

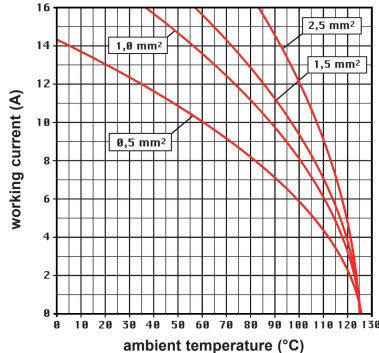

female inserts (CTF and CTSEF)

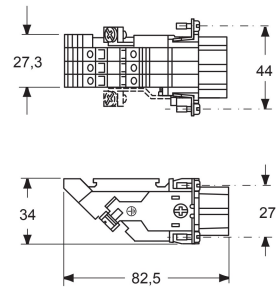

contacts side (front view)

female inserts (CTF and CTSEF)

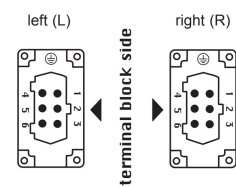

male inserts (CTM and CTSEM)

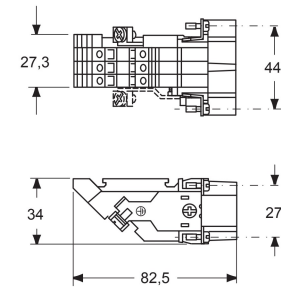

male inserts (CTM and CTSEM)

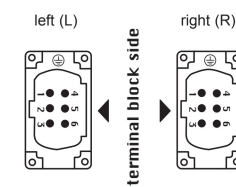

- CT inserts with plate, for section conductors: 0,75 - 2,5 mm² - AWG 18 - 14
- conductors stripping length: 12 mm
- terminal screw torque: 0,4 Nm (3,54 lb.in), for more information see page 20 and 21

- CTSE spring inserts for section conductors: 0,14 - 2,5 mm² - AWG 26 - 14
- conductors stripping length: 9...11 mm

Connection technology with spring terminal

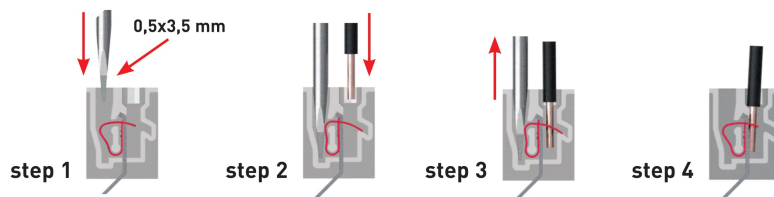

CT - CTSE

CT 10 poles + ⊕ 16A - 400V CTSE 10 poles + ⊕ 16A - 500V

enclosures *): size "57.27"	page:
C-TYPE IP65 or IP66/IP69	393
C7 IP67, two levers	438
V-TYPE IP65 or IP66/IP69, single lever	448 - 449
BIG hoods	468 - 469
T-TYPE IP65 insulating	482 - 483
T-TYPE / W IP66/IP69 insulating	490
HYGIENIC T-TYPE / H IP66/IP69	502
HYGIENIC T-TYPE / C IP66/IP69, -50 °C	507
W-TYPE for aggressive environments	522
E-Xtreme® corrosion proof	532, 543
EMC	579
Central lever	606
LS-TYPE	620

*) only bulkhead mounted housings and BIG hoods

- can be mated with CNE, CCE, CSS, CSH inserts
- inserts may be fitted from front of enclosure

**terminal block inserts
screw terminal connection**

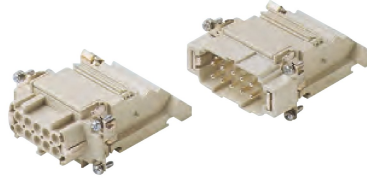

Q SILVER PLATED CONTACTS

**terminal block inserts
spring terminal connection**

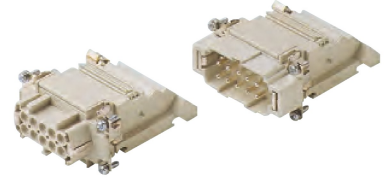

Q SILVER PLATED CONTACTS

description	part No.	part No.	part No.	part No.
mounting side (see page 159)	left	right	left	right
female inserts with female contacts ¹⁾	CTF 10 L	CTF 10 R	CTSEF 10 L	CTSEF 10 R
male inserts with male contacts ¹⁾	CTM 10 L	CTM 10 R	CTSEM 10 L	CTSEM 10 R
mounting side (see page 159)				
female inserts with female contacts				
male inserts with male contacts				

¹⁾ for non-prepared conductors

- characteristics according to EN 61984:
- 16A 230/400V 4kV 3 (CT)**
- 16A 400V 4kV 2 (CT)**
- 16A 500V 6kV 3 (CTSE)**
- 16A 400/690V 6kV 2 (CTSE)**

- certified (CT)
- certified (CTSE)
- rated voltage according to UL/CSA: 600V
- insulation resistance: ≥ 10 GΩ
- ambient temperature limit: -40 °C ... +125 °C
- made of self-extinguishing thermoplastic resin UL 94V-0
- mechanical life: ≥ 500 cycles
- contact resistance: ≤ 4 mΩ
- for max. current load see the connector inserts derating diagrams below; for more information see page 28

female inserts (CTF and CTSEF)

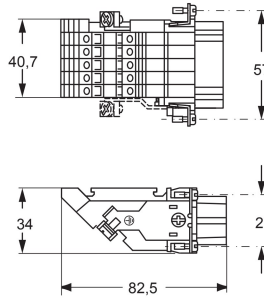

male inserts (CTM and CTSEM)

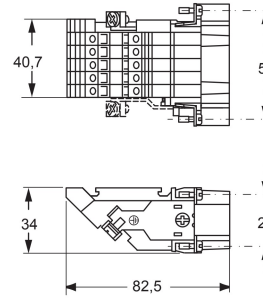

contacts side (front view)

female inserts (CTF and CTSEF)

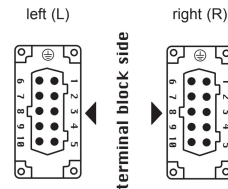

male inserts (CTM and CTSEM)

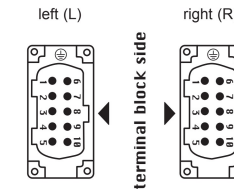

- CT inserts with plate, for section conductors: 0,75 - 2,5 mm² - AWG 18 - 14
- conductors stripping length: 12 mm
- terminal screw torque: 0,4 Nm (3,54 lb.in), for more information see page 20 and 21

- CTSE spring inserts for section conductors: 0,14 - 2,5 mm² - AWG 26 - 14
- conductors stripping length: 9...11 mm

**CT 10 poles connector inserts
Maximum current load derating diagram**

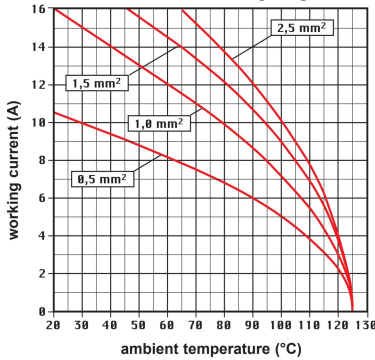

**CTSE 10 poles connector inserts
Maximum current load derating diagram**

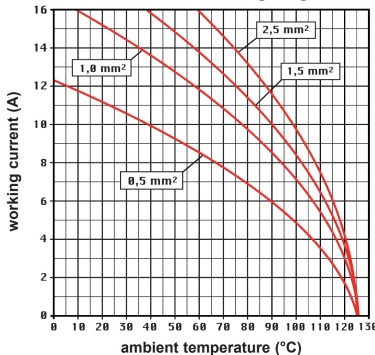

Connection technology with spring terminal

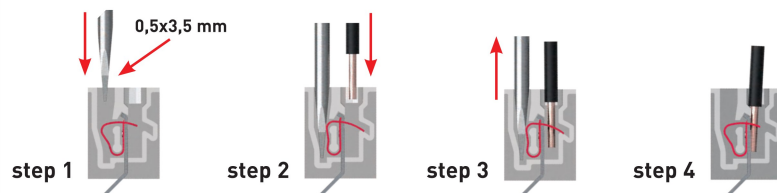

enclosures *):
size "77.27"

page:

C-TYPE IP65 or IP66/IP69	402
C7 IP67, two levers	439 - 440
V-TYPE IP65 or IP66/IP69, single lever	454 - 455
BIG hoods	470 - 471
T-TYPE IP65 insulating	484 - 485
T-TYPE / W IP66/IP69 insulating	491
HYGIENIC T-TYPE / H IP66/IP69	503
HYGIENIC T-TYPE / C IP66/IP69, -50 °C	508
W-TYPE for aggressive environments	523
E-Xtreme® corrosion proof	534, 544
EMC	580
Central lever	609
LS-TYPE	622

*) only bulkhead mounted housings and BIG hoods

- can be mated with CNE, CCE, CSS, CSH inserts
- inserts may be fitted from front of enclosure

terminal block inserts
screw terminal connection

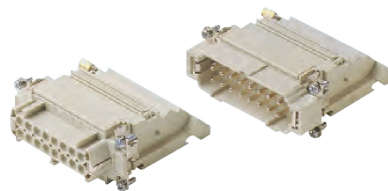

Q SILVER PLATED CONTACTS

terminal block inserts
spring terminal connection

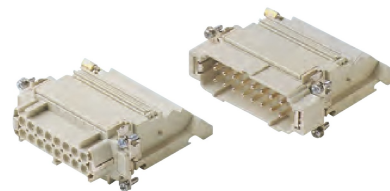

Q SILVER PLATED CONTACTS

description

part No.

part No.

part No.

part No.

mounting side (see page 159)
female inserts with female contacts ¹⁾
male inserts with male contacts ¹⁾

left
CTF 16 L
CTM 16 L

right
CTF 16 R
CTM 16 R

mounting side (see page 159)
female inserts with female contacts
male inserts with male contacts

left
CTSEF 16 L
CTSEM 16 L

right
CTSEF 16 R
CTSEM 16 R

1) for non-prepared conductors

- characteristics according to EN 61984:
- 16A 230/400V 4kV 3 (CT)**
- 16A 400V 4kV 2 (CT)**
- 16A 500V 6kV 3 (CTSE)**
- 16A 400/690V 6kV 2 (CTSE)**

certified (CT)

certified (CTSE)

- rated voltage according to UL/CSA: 600V
- insulation resistance: ≥ 10 GΩ
- ambient temperature limit: -40 °C ... +125 °C
- made of self-extinguishing thermoplastic resin UL 94V-0
- mechanical life: ≥ 500 cycles
- contact resistance: ≤ 4 mΩ
- for max. current load see the connector inserts derating diagrams below; for more information see page 28

CT 16 poles connector inserts
Maximum current load derating diagram

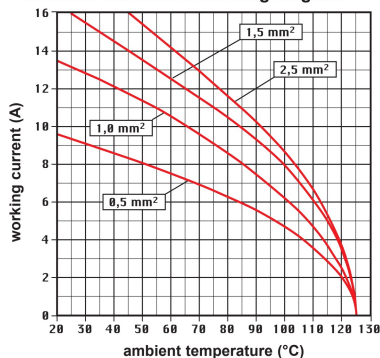

CTSE 16 poles connector inserts
Maximum current load derating diagram

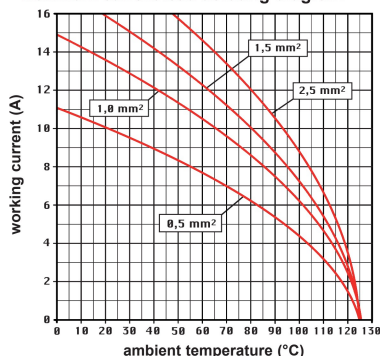

female inserts (CTF and CTSEF)

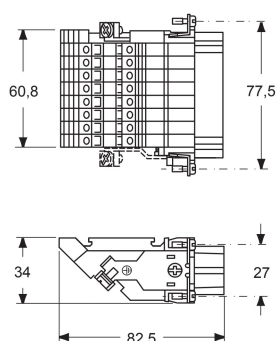

contacts side (front view)

female inserts (CTF and CTSEF)

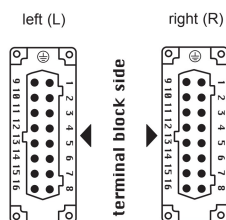

- CT inserts with plate, for section conductors: 0,75 - 2,5 mm² - AWG 18 - 14
- conductors stripping length: 12 mm
- terminal screw torque: 0,4 Nm (3,54 lb.in), for more information see page 20 and 21

male inserts (CTM and CTSEM)

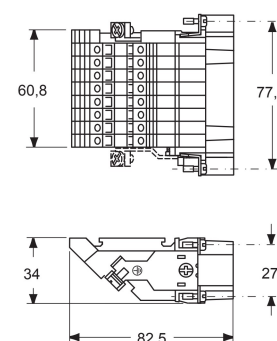

male inserts (CTM and CTSEM)

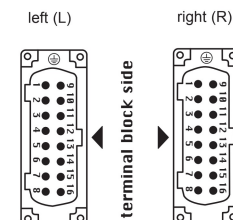

- CTSE spring inserts for section conductors: 0,14 - 2,5 mm² - AWG 26 - 14
- conductors stripping length: 9...11 mm

Connection technology with spring terminal

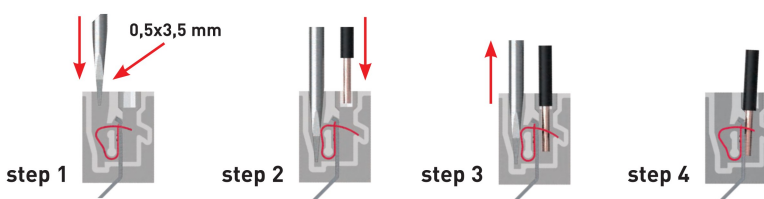

CT - CTSE

CT 24 poles + ⊕ 16A - 400V CTSE 24 poles + ⊕ 16A - 500V

enclosures *): size "104.27"	page:
C-TYPE IP65 or IP66/IP69	412
C7 IP67, two levers	441 - 442
V-TYPE IP65 or IP66/IP69, single lever	459 - 460
BIG hoods	472 - 473
T-TYPE IP65 insulating	486 - 487
T-TYPE / W IP66/IP69 insulating	492
HYGIENIC T-TYPE / H IP66/IP69	504
HYGIENIC T-TYPE / C IP66/IP69, -50 °C	509
W-TYPE for aggressive environments	524
E-Xtreme® corrosion proof	536, 545
EMC	581
Central lever	612
LS-TYPE	624

*) only bulkhead mounted housings and BIG hoods

- can be mated with CNE, CCE, CSS, CSH inserts
- inserts may be fitted from front of enclosure

**terminal block inserts
screw terminal connection**

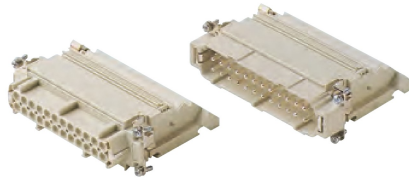

Q SILVER PLATED CONTACTS

**terminal block inserts
spring terminal connection**

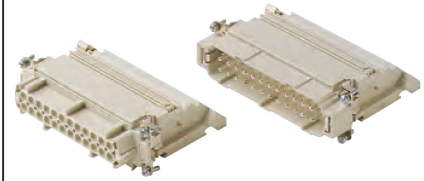

Q SILVER PLATED CONTACTS

description	part No.	part No.	part No.	part No.
mounting side (see page 159)	left	right	left	right
female inserts with female contacts ¹⁾	CTF 24 L	CTF 24 R	CTSEF 24 L	CTSEF 24 R
male inserts with male contacts ¹⁾	CTM 24 L	CTM 24 R	CTSEM 24 L	CTSEM 24 R
mounting side (see page 159)				
female inserts with female contacts				
male inserts with male contacts				

¹⁾ for non-prepared conductors

- characteristics according to EN 61984:
- **16A 230/400V 4kV 3 (CT)**
- **16A 400V 4kV 2 (CT)**
- **16A 500V 6kV 3 (CTSE)**
- **16A 400/690V 6kV 2 (CTSE)**
- certified (CT)
- certified (CTSE)
- rated voltage according to UL/CSA: 600V
- insulation resistance: ≥ 10 GΩ
- ambient temperature limit: -40 °C ... +125 °C
- made of self-extinguishing thermoplastic resin UL 94V-0
- mechanical life: ≥ 500 cycles
- contact resistance: ≤ 4 mΩ
- for max. current load see the connector inserts derating diagrams below; for more information see page 28

**CT 24 poles connector inserts
Maximum current load derating diagram**

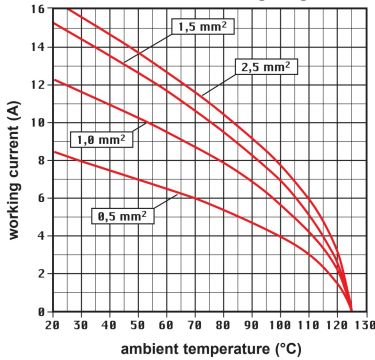

**CTSE 24 poles connector inserts
Maximum current load derating diagram**

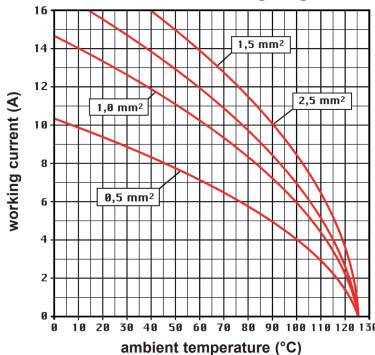

female inserts (CTF and CTSEF)

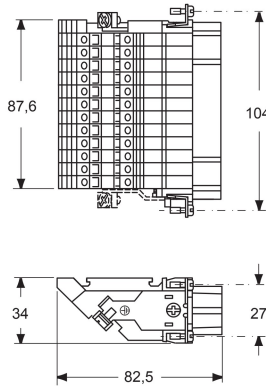

**contacts side (front view)
female inserts (CTF and CTSEF)**

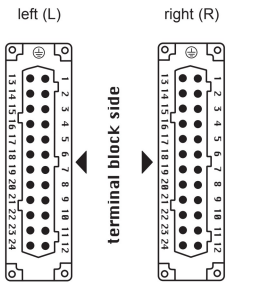

- CT inserts with plate, for section conductors: 0,75 - 2,5 mm² - AWG 18 - 14
- conductors stripping length: 12 mm
- terminal screw torque: 0,4 Nm (3,54 lb.in), for more information see page 20 and 21

male inserts (CTM and CTSEM)

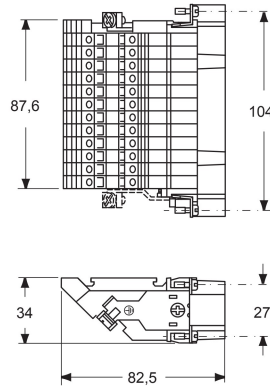

**male inserts (CTM and CTSEM)
left (L) right (R)**

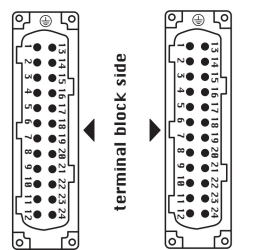

- CTSE spring inserts for section conductors: 0,14 - 2,5 mm² - AWG 26 - 14
- conductors stripping length: 9...11 mm

Connection technology with spring terminal

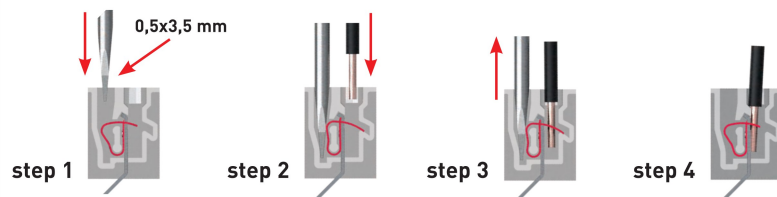

CTSE 32 poles + ⊕ 16A - 500V

enclosures *):
size "77.62"

page:

C-TYPE IP65 or IP66/IP69	424
W-TYPE for aggressive environments	525
E-Xtreme® corrosion proof	546

*) only bulkhead mounted housings

terminal block inserts
spring terminal connection

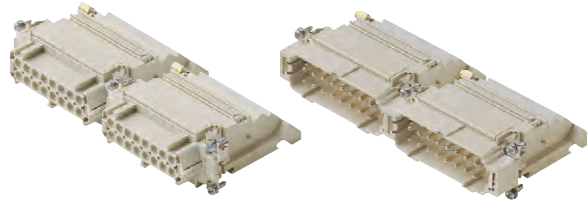

Q SILVER PLATED CONTACTS

description	part No.	part No.	part No.	part No.
mounting side (see page 159)				
female inserts with female contacts, No. (1-16) and (17-32) ¹⁾	left CTSEF 16 LN	right CTSEF 16 R	left CTSEF 16 L	right CTSEF 16 RN
male inserts with male contacts, No. (1-16) and (17-32) ¹⁾	CTSEM 16 LN	CTSEM 16 R	CTSEM 16 L	CTSEM 16 RN

1) for non-prepared conductors

- characteristics according to EN 61984:

16A 500V 6kV 3
16A 400/690V 6kV 2

- certified

- rated voltage according to UL/CSA: 600V
- insulation resistance: $\geq 10 \text{ G}\Omega$
- ambient temperature limit: $-40 \text{ }^\circ\text{C} \dots +125 \text{ }^\circ\text{C}$
- made of self-extinguishing thermoplastic resin UL 94V-0
- mechanical life: ≥ 500 cycles
- contact resistance: $\leq 4 \text{ m}\Omega$
- for max. current load see the connector inserts derating diagrams below; for more information see page 28

female inserts (CTSEF)

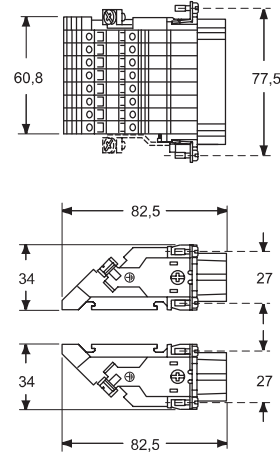

male inserts (CTSEM)

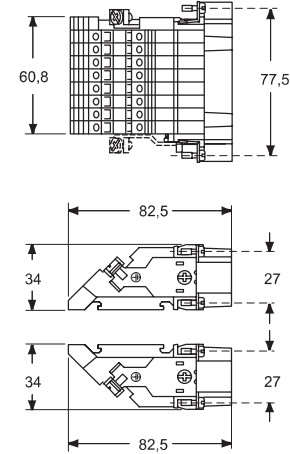

contacts side (front view)

female inserts (CTSEF)

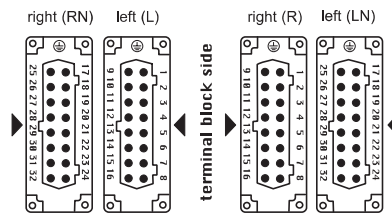

male inserts (CTSEM)

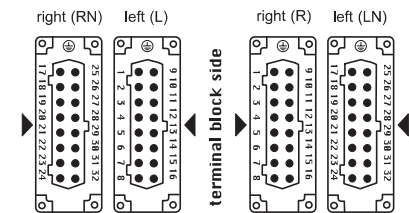

CTSE 32 poles connector inserts
Maximum current load derating diagram

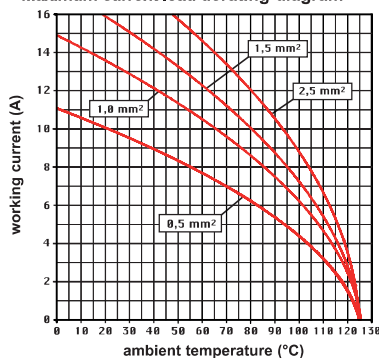

- CTSE spring inserts for section conductors: $0,14 - 2,5 \text{ mm}^2$ - AWG 26 - 14
- conductors stripping length: $9...11 \text{ mm}$

Connection technology with spring terminal

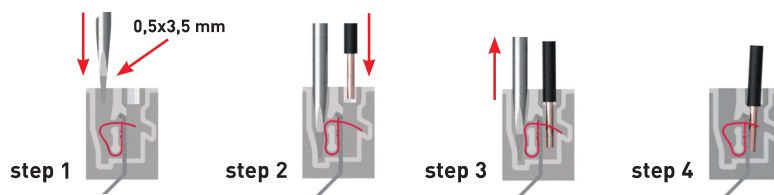

CTSE 48 poles + ⊕ 16A - 500V

enclosures *):
size "104.62"

page:

C-TYPE IP65 or IP66/IP69	430
W-TYPE for aggressive environments	526
E-Xtreme® corrosion proof	547

*) only bulkhead mounted housings

terminal block inserts spring terminal connection

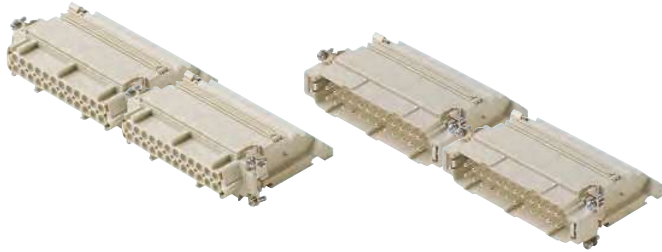

Q SILVER PLATED CONTACTS

description	part No.	part No.	part No.	part No.
mounting side (see page 159)	left	right	left	right
female inserts with female contacts, No. (1-24) and (25-48) ¹⁾	CTSEF 24 LN	CTSEF 24 R	CTSEF 24 L	CTSEF 24 RN
male inserts with male contacts, No. (1-24) and (25-48) ¹⁾	CTSEM 24 LN	CTSEM 24 R	CTSEM 24 L	CTSEM 24 RN

¹⁾ for non-prepared conductors

- characteristics according to EN 61984:
16A 500V 6kV 3
16A 400/690V 6kV 2
- certified
- rated voltage according to UL/CSA: 600V
- insulation resistance: ≥ 10 GΩ
- ambient temperature limit: -40 °C ... +125 °C
- made of self-extinguishing thermoplastic resin UL 94V-0
- mechanical life: ≥ 500 cycles
- contact resistance: ≤ 4 mΩ
- for max. current load see the connector inserts derating diagrams below; for more information see page 28

female inserts (CTSEF)

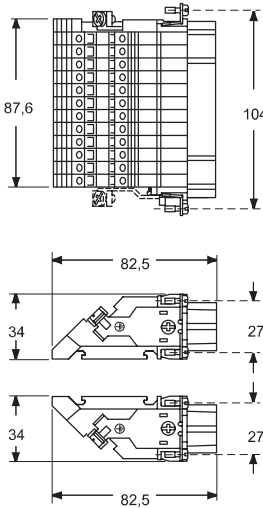

contacts side (front view)

female inserts (CTSEF)

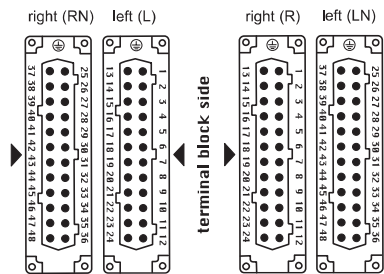

male inserts (CTSEM)

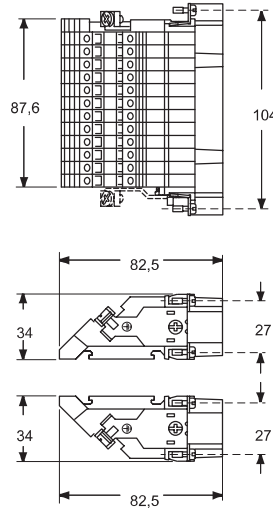

male inserts (CTSEM)

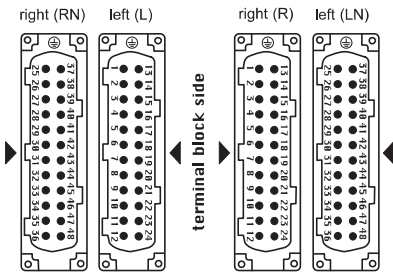

CTSE 48 poles connector inserts
Maximum current load derating diagram

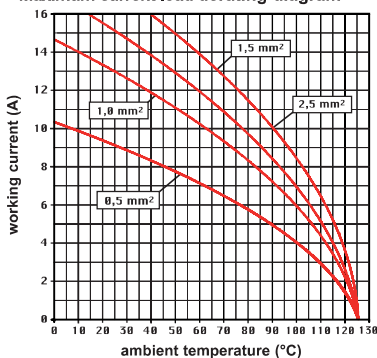

- CTSE spring inserts for section conductors: 0,14 - 2,5 mm² - AWG 26 - 14
- conductors stripping length: 9...11 mm

Connection technology with spring terminal

