

# xirodur® B180 Polymer Ball Bearings | Product Range

## Radial deep-groove ball bearings

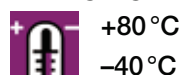

Made of xirodur® B180  
PA cage, glass balls



Made of xirodur® B180  
PA cage, stainless steel balls

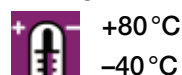

xiros® B180 polymer ball bearings are for use with temperatures up to +80 °C. The specially developed material xirodur® B180 provides significantly longer life times at a lower cost.

- Lubrication- and maintenance-free
- Non-magnetic and washable
- Corrosion-resistant
- Predictable lifetime
- Low weight
- For shaft diameters 3–60 mm
- Electrically insulating

## Dimensions [mm]

Part number	Race	Cage	Ball	Inner-Ø d1	Outer-Ø d2	Width b1
BB-623-B180-10-ES	B180	PA	1.4401	3	10	4
BB-625-B180-10-ES <b>New!</b>	B180	PA	1.4401	5	16	6
BB-626-B180-10-ES	B180	PA	1.4401	6	19	6
BB-608-B180-10-ES	B180	PA	1.4401	8	22	7
BB-6000-B180-10-ES	B180	PA	1.4401	10	26	8
BB-6001-B180-10-ES	B180	PA	1.4401	12	28	8
BB-6002-B180-10-ES <b>New!</b>	B180	PA	1.4401	15	32	9
BB-6003-B180-10-ES	B180	PA	1.4401	17	35	10
BB-6004-B180-10-ES	B180	PA	1.4401	20	42	12
BB-6005-B180-10-ES	B180	PA	1.4401	25	47	12
BB-6006-B180-10-ES*	B180	PA	1.4401	30	55	13
BB-6007-B180-10-ES*	B180	PA	1.4401	35	62	14
BB-6008-B180-10-ES*	B180	PA	1.4401	40	68	15
BB-6009-B180-10-ES*	B180	PA	1.4401	45	75	16
BB-6010-B180-10-ES*	B180	PA	1.4401	50	80	16
BB-6011-B180-10-ES*	B180	PA	1.4401	55	90	18
BB-6012-B180-10-ES*	B180	PA	1.4401	60	95	18
BB-623-B180-10-GL	B180	PA	Glass	3	10	4
BB-625-B180-10-GL <b>New!</b>	B180	PA	Glass	5	16	6
BB-626-B180-10-GL	B180	PA	Glass	6	19	6
BB-608-B180-10-GL	B180	PA	Glass	8	22	7
BB-6000-B180-10-GL	B180	PA	Glass	10	26	8
BB-6001-B180-10-GL	B180	PA	Glass	12	28	8
BB-6002-B180-10-GL <b>New!</b>	B180	PA	Glass	15	32	9
BB-6003-B180-10-GL	B180	PA	Glass	17	35	10
BB-6004-B180-10-GL	B180	PA	Glass	20	42	12
BB-6005-B180-10-GL	B180	PA	Glass	25	47	12
BB-6006-B180-10-GL*	B180	PA	Glass	30	55	13
BB-6007-B180-10-GL*	B180	PA	Glass	35	62	14
BB-6008-B180-10-GL*	B180	PA	Glass	40	68	15
BB-6009-B180-10-GL*	B180	PA	Glass	45	75	16
BB-6010-B180-10-GL*	B180	PA	Glass	50	80	16
BB-6011-B180-10-GL*	B180	PA	Glass	55	90	18
BB-6012-B180-10-GL*	B180	PA	Glass	60	95	18

# xirodur® B180 Polymer Ball Bearings | Product Range

Radial deep-groove ball bearings

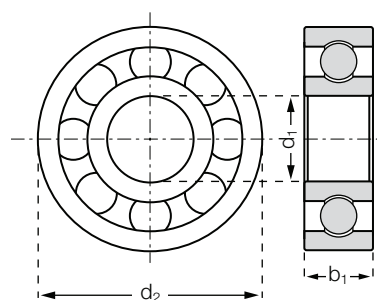

Order key

**BB-623-B180-10-GL**



**Ball material**

GL = glass

ES = stainless steel

**Cage material**

10 = PA

**Race material**

xirodur® B180

**Dimensions acc. to**

**DIN 625-1**

**Ball bearing**



**delivery  
time**

available from stock

\* on request

## Technical Data

Part number	Max. stat. bearing load axial [N]	Stat. bearing load [N]	Dynamic bearing load [N]	Max. speed [rpm]	Weight [g]
BB-623-B180-10-ES	30	25	35	4,500	0.4
BB-625-B180-10-ES <b>New!</b>	75	40	58	3,100	1.6
BB-626-B180-10-ES	95	50	70	2,600	2.2
BB-608-B180-10-ES	165	60	84	2,200	3.9
BB-6000-B180-10-ES	285	85	119	1,900	6.1
BB-6001-B180-10-ES	315	105	147	1,750	6.9
BB-6002-B180-10-ES <b>New!</b>	338	146	196	1,600	8.9
BB-6003-B180-10-ES	360	180	250	1,400	11.1
BB-6004-B180-10-ES	400	210	294	1,150	20.2
BB-6005-B180-10-ES	520	240	360	1,050	23.9
BB-6006-B180-10-ES*	640	280	420	900	35.0
BB-6007-B180-10-ES*	720	320	480	800	47.0
BB-6008-B180-10-ES*	800	350	520	750	56.3
BB-6009-B180-10-ES*	900	380	560	650	71.5
BB-6010-B180-10-ES*	950	390	580	600	83.1
BB-6011-B180-10-ES*	1,000	400	600	550	125.2
BB-6012-B180-10-ES*	1,100	420	640	500	129.6
BB-623-B180-10-GL	30	25	35	4,500	0.3
BB-625-B180-10-GL <b>New!</b>	75	40	58	3,100	1.0
BB-626-B180-10-GL	95	50	70	2,600	1.7
BB-608-B180-10-GL	165	60	84	2,200	2.6
BB-6000-B180-10-GL	285	85	119	1,900	4.0
BB-6001-B180-10-GL	315	105	147	1,750	4.5
BB-6002-B180-10-GL <b>New!</b>	338	146	196	1,600	6.2
BB-6003-B180-10-GL	360	180	250	1,400	7.9
BB-6004-B180-10-GL	400	210	294	1,150	13.6
BB-6005-B180-10-GL	520	240	360	1,050	16.7
BB-6006-B180-10-GL*	640	280	420	900	24.2
BB-6007-B180-10-GL*	720	320	480	800	31.3
BB-6008-B180-10-GL*	800	350	520	750	39.1
BB-6009-B180-10-GL*	900	380	560	650	48.6
BB-6010-B180-10-GL*	950	390	580	600	56.4
BB-6011-B180-10-GL*	1,000	400	600	550	84.4
BB-6012-B180-10-GL*	1,100	420	640	500	85.6

## Radial deep-groove ball bearings with shield

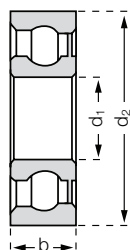
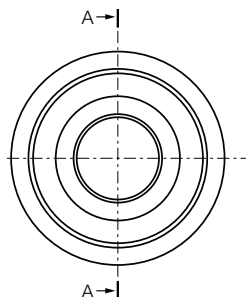

Made of xirodur® B180

PA cage, stainless steel or glass balls



+80 °C

-40 °C

xiros® polymer ball bearings made of xirodur® B180 now with shield to prevent the penetration of dirt and other abrasive particles. The one-sided shield is fixed to the inner race. The other side is protected by the enclosed ball cage.

- Lubrication- and maintenance-free
- Dirt-repellant
- Corrosion-resistant
- Low weight
- For shaft diameter 3–20 mm
- Electrically insulating

## Dimensions [mm]

Part number	Race	Cage	Ball	Inner-Ø	Outer-Ø	Width
				d1	d2	b1
BB-623-B180-10-ES-C	B180	PA	1.4401	3	10	4
BB-626-B180-10-ES-C	B180	PA	1.4401	6	19	6
BB-608-B180-10-ES-C	B180	PA	1.4401	8	22	7
BB-6000-B180-10-ES-C	B180	PA	1.4401	10	26	8
BB-6001-B180-10-ES-C	B180	PA	1.4401	12	28	8
BB-6003-B180-10-ES-C	B180	PA	1.4401	17	35	10
BB-6004-B180-10-ES-C	B180	PA	1.4401	20	42	12
BB-623-B180-10-GL-C	B180	PA	Glass	3	10	4
BB-626-B180-10-GL-C	B180	PA	Glass	6	19	6
BB-608-B180-10-GL-C	B180	PA	Glass	8	22	7
BB-6000-B180-10-GL-C	B180	PA	Glass	10	26	8
BB-6001-B180-10-GL-C	B180	PA	Glass	12	28	8
BB-6003-B180-10-GL-C	B180	PA	Glass	17	35	10
BB-6004-B180-10-GL-C	B180	PA	Glass	20	42	12

## Technical Data

Part number	Max. static bearing load	Static bearing load	Dynamic bearing load	Max. speed	Weight
	axial [N]	[N]	[N]	[rpm]	[g]
BB-623-B180-10-ES-C	30	25	35	4,500	0.4
BB-626-B180-10-ES-C	95	50	70	2,600	2.5
BB-608-B180-10-ES-C	165	60	84	2,200	4.0
BB-6000-B180-10-ES-C	285	85	119	1,900	6.3
BB-6001-B180-10-ES-C	315	105	147	1,750	7.1
BB-6003-B180-10-ES-C	360	180	250	1,400	11.5
BB-6004-B180-10-ES-C	400	210	294	1,150	19.7
BB-623-B180-10-GL-C	30	25	35	4,500	0.4
BB-626-B180-10-GL-C	95	50	70	2,600	1.8
BB-608-B180-10-GL-C	165	60	84	2,200	2.7
BB-6000-B180-10-GL-C	285	85	119	1,900	4.1
BB-6001-B180-10-GL-C	315	105	147	1,750	4.7
BB-6003-B180-10-GL-C	360	180	250	1,400	8.4
BB-6004-B180-10-GL-C	400	210	294	1,150	14.2

# xiros® Polymer Ball Bearings

xiros® polymer ball bearings revolutionize the market. Due to the maintenance-free dry-running and the use of xirodur® high performance polymers successfully solve many applications where conventional metal ball bearings are not effective.

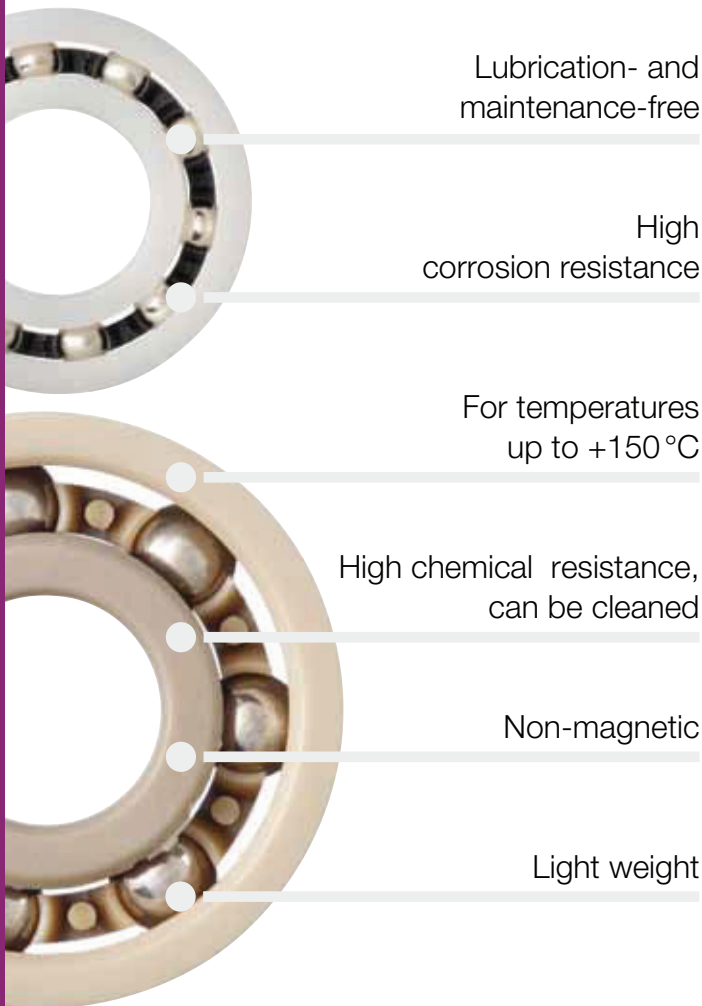

Lubrication- and maintenance-free

High corrosion resistance

For temperatures up to +150 °C

High chemical resistance, can be cleaned

Non-magnetic

Light weight

## Temperature

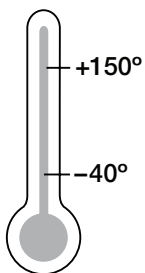

## Product range

5 materials  
10 product types



### When to use xiros® polymer ball bearings?

- If you need lubrication-free ball bearings
- For maintenance-free dry-running
- At rotational speeds that exceed the limits of a plain bearing
- If corrosion resistance is required
- If temperatures are reached up to +150 °C (depending on type)
- If chemical resistance and cleaning is necessary
- If non-magnetics ball bearings are to be used
- Low weight requirement
- When they need for FDA compliance



### When not to use xiros® polymer ball bearings?

- At very high loads or speeds
- Just for a cost down on traditional metal ball bearings
- At very high precision requirements (clearance)



### General order key for radial ball bearings

## BB-623-A500-10-ES

#### Ball material

GL = glass  
ES = stainless steel  
PAI

#### Cage material

10 = PA  
20 = PP  
70 = PEEK

#### Race material

xirodur® A500, xirodur® B180,  
xirodur® C160, xirodur®  
D180, xirodur® F180

#### Dimensions acc. to DIN 625-1

Ball bearing



# xiros® Polymer Ball Bearings

The product range of xiros® polymer ball bearing comprises a variety of different product groups. All have in common that they do not require any additional lubrication. This provides significant advantages in areas where lubricants can be washed out, or could decompose due to the operational environment. Other advantages are (depending on the design):

- Maintenance-free
- Light weight
- Free from metal (due to the use of glass and plastic balls)
- Non-magnetic
- Chemical resistant
- Corrosion resistant
- Electrically insulating
- FDA-compliant (► [page 693](#))
- Predictable lifetime

This last point, the predictability of xiros® polymer ball bearing is one of the most important advantages. Based on the results of many wear tests, the user can calculate the lifetime of the xiros® polymer ball bearing reliably and interpret the application (xiros® expert ► [page 687](#)).

## Design

The xiros® polymer ball bearings are single-row grooved ball bearings based on DIN 625. The lubricant-free and maintenance-free ball bearings consist of four components:

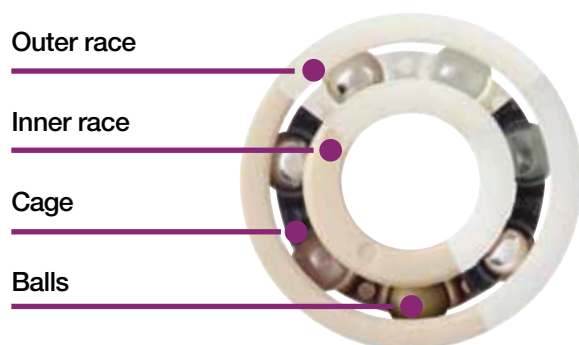

## The Outer- and Inner Race

The suitability of a xiros® polymer ball bearings is largely determined by the materials of the two races. These are made from igus® tribopolymers to maximize service life and minimize friction. You can choose from five different materials. They allow different values of application

temperature, chemical resistance and price. The table with material data (► [page 684](#)) gives exact information.

## The Cage

The material of the ball bearing cage must fit well to the application. These materials are very different regard to chemical resistance and temperature. As part of the delivery program of xiros® polymer ball bearings the cage are already great with the materials of the outer and inner rings.

## The Balls

The ball materials differ most significantly. In addition to steel glass or plastics are used. This produces a large difference in mass, which in turn affects smoothness, weight and chemical resistance.

Steelballs (stainless steel) are cost-effective, chemical resistant, but with the highest weight.

Glass balls used to give a metal-free solution. They are also very resistant to chemicals and have an average weight.

Polymer balls have significant advantages in weight, size and in the quiete rinning characteristics. Depending on the polymer plastic balls they can have excellent chemical resistance.

## Pillow Block and Flange Bearings

This range is made up by combining xiros® polymer ball bearing with the igubal® pillow block and flange bearings, resulting in a higher flexibility in terms of installation of the bearings. The pre-finished bearing housing make it easy for the user to use these maintenance-free components. Both flanged and pillow block available as fixed or as a pivoting design.

The difference between the two options is that the pivoting type can compensate for shaft and/or bearing misalignment. A spherical outer race is pressed into the bearing housing, ensuring self aligning action.

# xiros® Polymer Ball Bearings

## Application Areas

In contrast to metallic ball bearings, xiros® polymer ball bearings run without any lubrication. For this reason they are suitable for many applications which do not have extreme speeds or loads but ones which cannot use traditional greased ball bearings, as the application should run maintenance free. These areas are for example food and medical industries, packaging and textile industries, or the chemical industry and cleanroom applications as well as electronics and office technology.

## Development and Tests

Through numerous tests the race materials were optimised. The polymers we have developed for use with ball bearings allow higher speeds, greater loads, and longer service life. But the development continues, we believe that polymer ball bearing technology will continue to advance, especially with our experience and development with tribological polymer materials.

Challenge us, talk to us about your applications, tell us what you need from a plastic ball bearing.

In the igus® test laboratory the life and wear of xiros® polymer ball bearings was tested. In addition to the actual material comparison, tests indicate these experiments also answer questions about the impact of external influences such as temperature, humidity or dust.

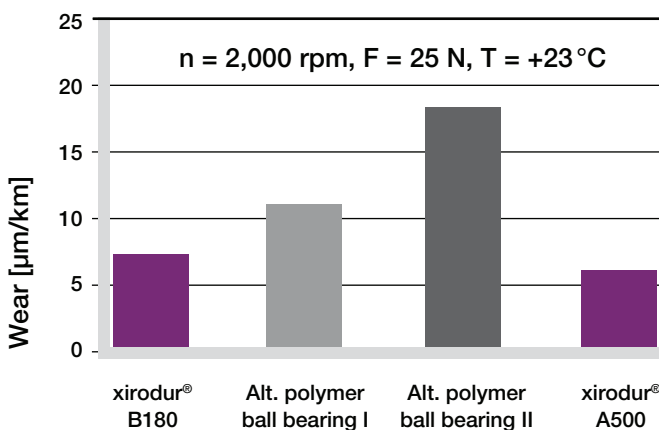

Graph 01: Wear test in igus® laboratory

The material combinations for bearing races, balls and cage are tested in the igus® test laboratory for a variety of load and speed. Thus, the application-specific selection of the suitable bearing and a Lifetime calculation is possible.

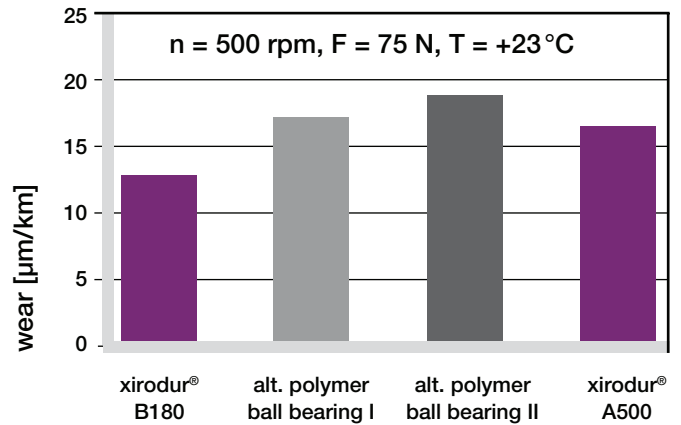

Graph 02: Wear test in igus® laboratory

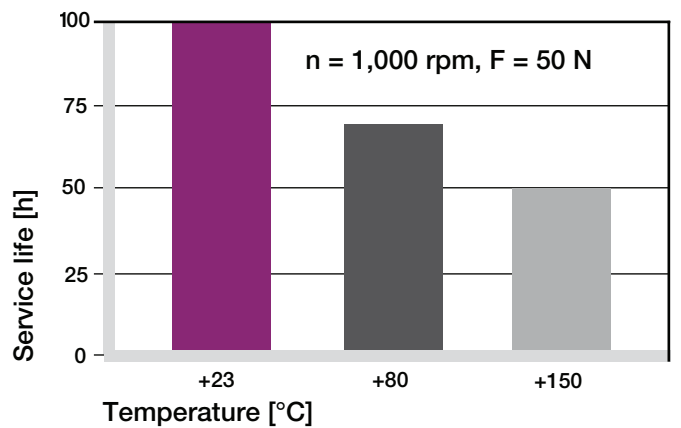

Graph 03: Service life of xirodur® A500 polymer ball bearings at different ambient temperatures, dry

## Predictability

As part of the development of xiros® polymer ball bearing tests are carried out continuously. The extreme number of test results make it very difficult to present this information in tabular form, and for it to actually make sense.



Picture 01: Test bench for xiros® polymer ball bearings at igus® laboratory

# xiros® Polymer Ball Bearings

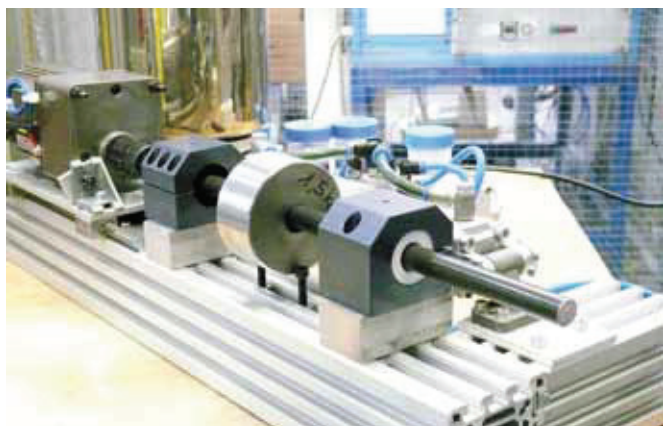

Picture 02: Test bench for xiros® polymer ball bearings at igus® laboratory

It is for this reason that igus has developed the online life calculator, which uses real test results to give an accurate calculation.

The lifetime-calculator is online at

► [www.igus.eu/xiros-expert](http://www.igus.eu/xiros-expert)

Immediately after entering the data, the lifetime is calculated and displayed. It is important to remember that the result given is based on actual test results in the igus laboratory, and is therefore totally reliable.

### xiros® service life prediction

**Your application parameters**

Installation size:

Max. speed:  rpm

Working temperature:  °C

Max. radial load:  N

Max. axial load (only if available):  N

**Selection of material combinations:**

Rings	Cage	Balls	FDA-compatible
A500	PEEK	Glass	-
A500	PA	Stainl.st.	-
A500	PEEK	Stainl.st.	●

Inner Ø d1 = 10 mm  
Outer Ø d2 = 26 mm  
Width b1 = 8 mm

**Data of the selected part**

Limit speed	1900 rpm
Max. static radial load	85 N
Max. dynamic radial load	119 N
Max. permitted axial load	285 N
Min. application temperature	-40 °C
Max. ambient temperature	80 °C

**Service Life** 333 h ✓

The service life refers only to the operating time. Intermittent service is not considered.

**Limit curve**

Part no.: ✓ BB-6000-B180-10-ES  Pieces Price: 5,42 EUR

Add to shopping basket

Help / Contact

PDF

Graduated prices

Catalog pages

Quote request

Change to shopping cart

Picture 03: xiros® expert for calculation service life online

Material table							
General properties	Unit	xirodur® A500	xirodur® B180	xirodur® C160	xirodur® D180	xirodur® F180	igumid G
Density	g/cm <sup>3</sup>	1,28	1,41	1,11	1,24	1,33	1,37
Colour		brown	white	opaque	blue	black	black
Max. moisture absorption at +23°C/50% r.h.	% weight	0,3	0,2	0,1	0,5	0,5	1,4
Max. water absorption	% weight	0,5	0,7	0,2	1,4	1,4	5,6
Mechanical properties							
Module of elasticity	MPa	3.600	2.500	1.900	130	975	7.800
Tensile strength at +20°C	MPa	140	68	35	n.d.	n.d.	240
Compressive strength		83	77	67	51	69	79
Electrical properties							
Specific volume resistance <sup>1)</sup>	Ωcm	> 10 <sup>14</sup>	> 10 <sup>14</sup>	> 10 <sup>14</sup>	> 10 <sup>14</sup>	> 10 <sup>5-10<sup>9</sup>2)</sup>	> 10 <sup>11</sup>
Surface resistance <sup>1)</sup>	Ω	> 10 <sup>13</sup>	> 10 <sup>14</sup>	> 10 <sup>14</sup>	> 10 <sup>14</sup>	> 10 <sup>5-10<sup>9</sup>2)</sup>	> 10 <sup>11</sup>
Thermal properties of xiros® polymer ball bearings							
Max. long term application temperatures	°C	+150	+80	+80	+80	+80	+120
Min. application temperatures (in combination with cage material)	°C	-100 (PEEK) -40 (PA)	-40	0	-50	-50	-40

<sup>1)</sup> only valid for xirodur® F180: the good conductivity of this material favours, under certain conditions, the corrosion generation on metallic parts

<sup>2)</sup> depending on the geometry

Table 01: Material data

Medium	Resistance					
	xirodur® A500	xirodur® B180	xirodur® C160	xirodur® D180	xirodur® F180	igumid G
Alcohol	+	+	+	+ to 0	+ to 0	+ to 0
Hydrocarbons	+	+	+ to 0	+	+	+
Greases, oils without additives	+	+	+	+	+	+
Fuels	+	+	+ to 0	+	+	+
Diluted acids	+	0 to -	+	+ to 0	+ to 0	0 to -
Strong acids	+	-	+ to 0	0	0	-
Diluted alkalines	+	+	+	+ to 0	+ to 0	+
Strong alkalines	+	+ to 0	+	+ to 0	+ to 0	0

Table 02: Chemical resistance of xiros® materials

### Recommendation of tolerance for bore and shaft at xiros® radial ball bearings

By default we recommend a H7-tolerance of the housing bore of xiros® radial ball bearings and a h6-tolerance of the shaft. For further questions about the dimensioning of the bore and the shaft please contact us.



Which combination of materials is the best for my application?

**Races**

- 1 xirodur® A500
- 2 xirodur® B180
- 3 xirodur® C160
- 4 xirodur® D180
- 5 xirodur® F180

**Cages**

- 6 PA
- 7 PEEK
- 8 PP

**Balls**

- 9 Stainless steel (ES)
- 10 Glass (GL)
- 11 PAI

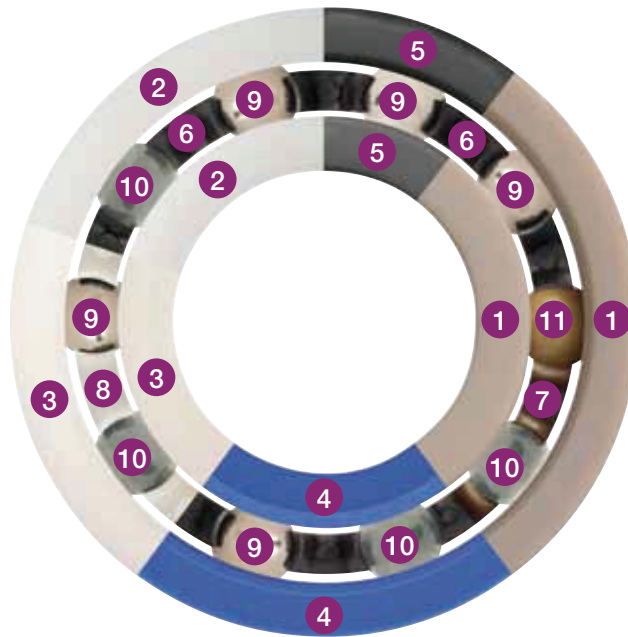

Material of inner-/outer races

Application sectors

Cage material

Ball material

Page

	xirodur® B180	xirodur® A500		xirodur® C160	xirodur® D180	xirodur® F180
Material of inner-/outer races	xirodur® B180	xirodur® A500		xirodur® C160	xirodur® D180	xirodur® F180
Application sectors	For cost-effective use	At high temperatures	With chemicals, FDA and high temperatures	With chemicals, temperatures up to +80 °C and for under water use	High rotation speed	Electrically conductive, ESD protection
Cage material	PA	PA	PEEK	PP	PA	PA
Ball material	ES   GL	ES   ES   GL   PAI	ES   GL   PAI	ES   GL	ES   GL	ES
	Cost-effective No metal	With high temperatures FDA compliance Chemicals Low loads	Depending on media: cost-effective Depending on media: seawater	Wear resistant Resistant to wear, chemicals and cleaning solutions	Conductive	
Page	686   686	691   689   690   692	693   693	694   694	695	