

iglidur® W300 | The Marathon Runner

Long service life, also for soft shafts. The iglidur® W300 material gives excellent wear resistance, even in harsh environments or when used with rough shafts. Of all iglidur® materials, iglidur® W300 is the most resistant to these conditions.

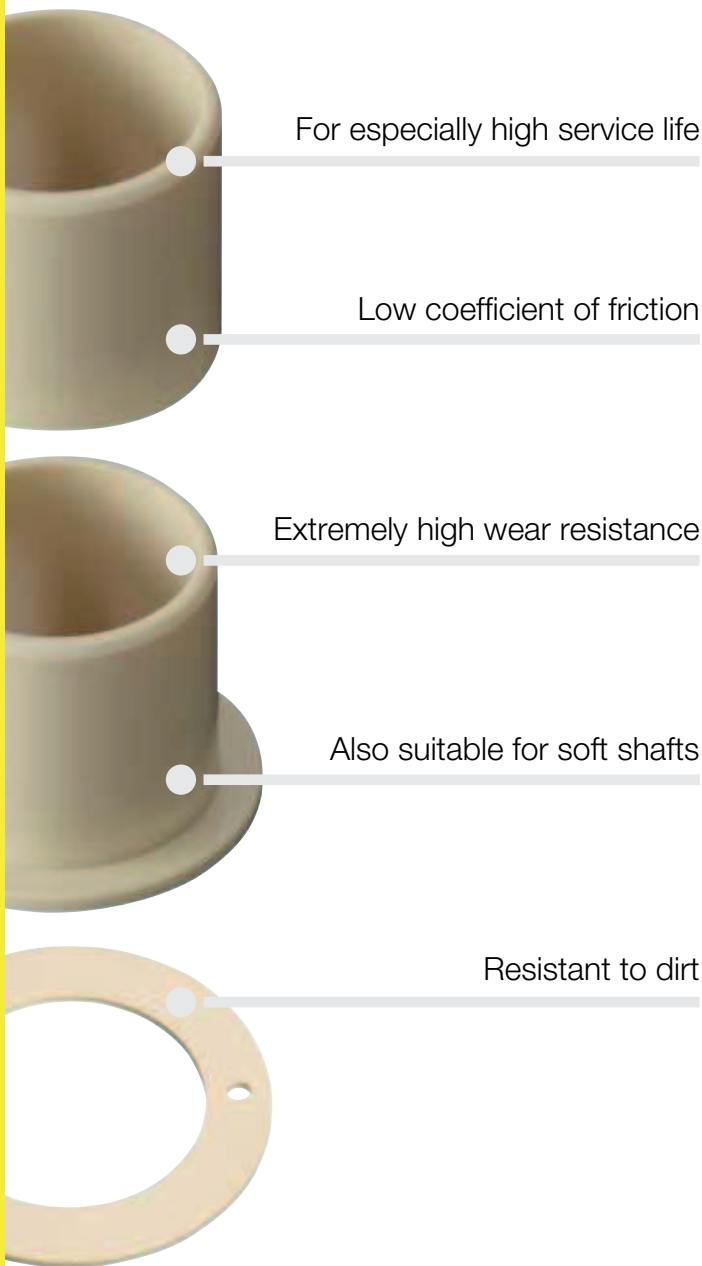

When to use it?

- When especially high service life is necessary
- When low coefficients of dynamic friction and high wear resistance are needed
- For use on 303 stainless steel shafts
- For harsh environments and very rough shafts
- Dirt resistant



When not to use it?

- For high loads starting at 50 MPa
▶ **iglidur® Q, page 461**
- When temperatures are constantly above +90 °C
▶ **iglidur® H, page 325**
▶ **iglidur® X, page 153**
- For very wet environments
▶ **iglidur® P, page 185**
- When an economical bearing is required
▶ **iglidur® G, page 61**

Temperature

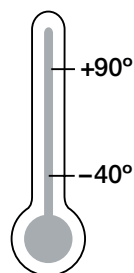

Product range

3 types
> 400 dimensions
Ø 2–120 mm



iglidur® W300 | Application Examples



Typical sectors of industry and application areas

- Automation ● Printing industry
- Woodworking ● Mechatronics
- Test engineering and quality assurance etc.

Improve technology and reduce costs – 310 exciting examples for iglidur® plain bearings online

► www.igus.eu/eu/iglidur-applications



► www.igus.eu/hydrogen-car



► www.igus.eu/concrete-machines



► www.igus.eu/rickshaw

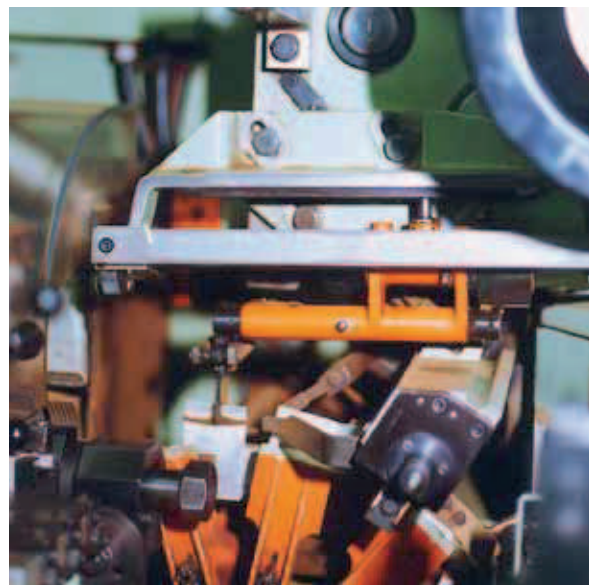

► www.igus.eu/teebag-packaging

Material data			
General properties	Unit	iglidur® W300	Testing method
Density	g/cm ³	1.24	
Colour		yellow	
Max. moisture absorption at +23 °C/50 % r.h.	% weight	1.3	DIN 53495
Max. moisture absorption	% weight	6.5	
Coefficient of sliding friction, dynamic against steel	μ	0.08–0.23	
pv value, max. (dry)	MPa · m/s	0.23	
Mechanical properties			
Modulus of elasticity	MPa	3,500	DIN 53457
Tensile strength at +20 °C	MPa	125	DIN 53452
Compressive strength	MPa	61	
Max. recommended surface pressure (+20 °C)	MPa	60	
Shore D hardness		77	DIN 53505
Physical and thermal properties			
Max. long term application temperature	°C	+90	
Max. short term application temperature	°C	+180	
Min. application temperature	°C	-40	
Thermal conductivity	W/m · K	0.24	ASTM C 177
Coefficient of thermal expansion (at +23 °C)	K ⁻¹ · 10 ⁻⁵	9	DIN 53752
Electrical properties			
Specific volume resistance	Ωcm	> 10 ¹³	DIN IEC 93
Surface resistance	Ω	> 10 ¹²	DIN 53482

Table 01: Material data

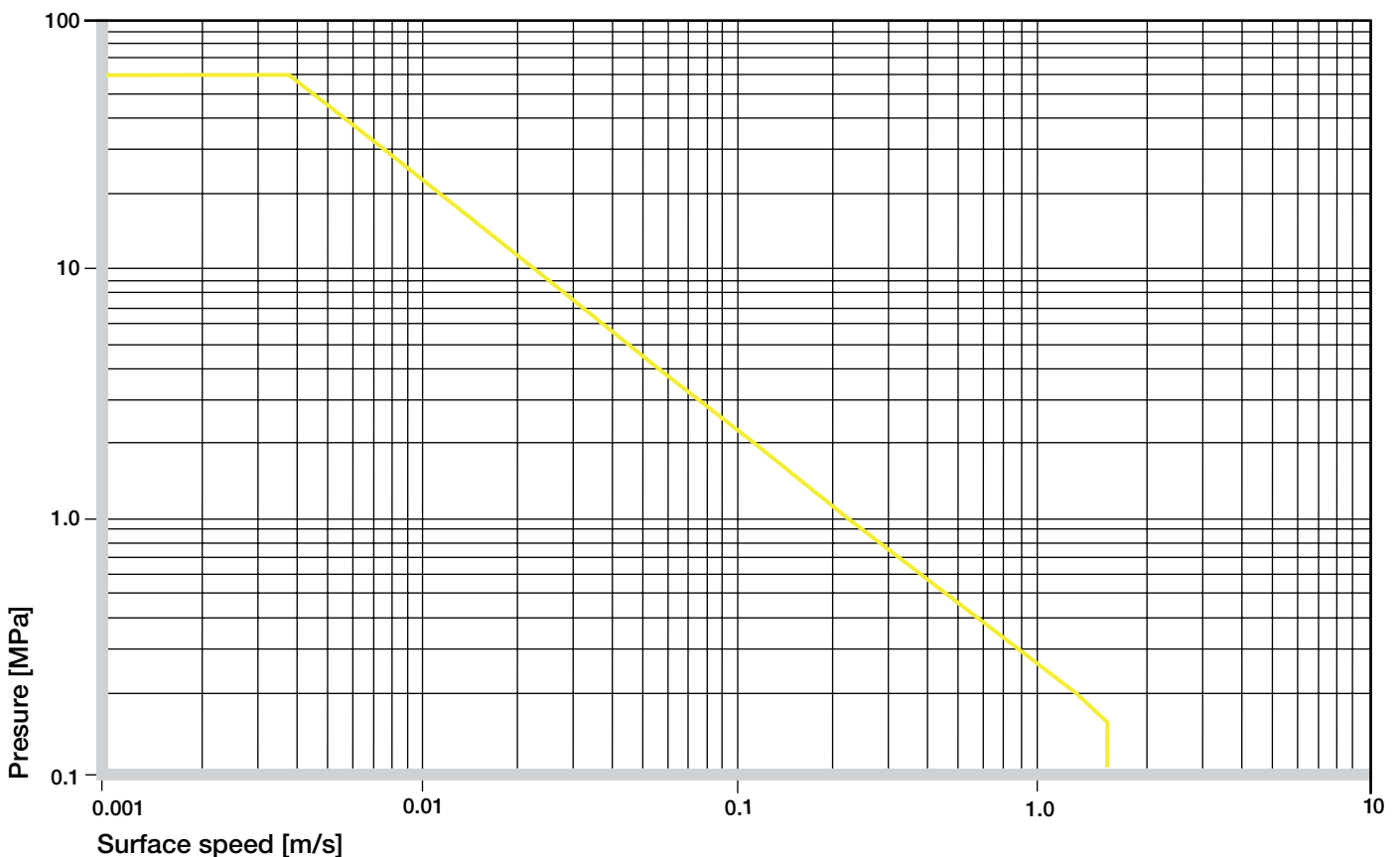

Graph 01: Permissible pv values for iglidur® W300 with a wall thickness of 1 mm dry running against a steel shaft at +20 °C, mounted in a steel housing

iglidur® W300 | Technical Data

Mechanical Properties

The recommended maximum surface pressure is a mechanical material parameter. No conclusions regarding the tribological properties can be drawn from this. With increasing temperatures, the compressive strength of iglidur® W300 plain bearings decreases. The Graph 02 shows this inverse relationship. However, at the longterm maximum temperature of +90 °C the permissible surface pressure is almost 30 MPa.

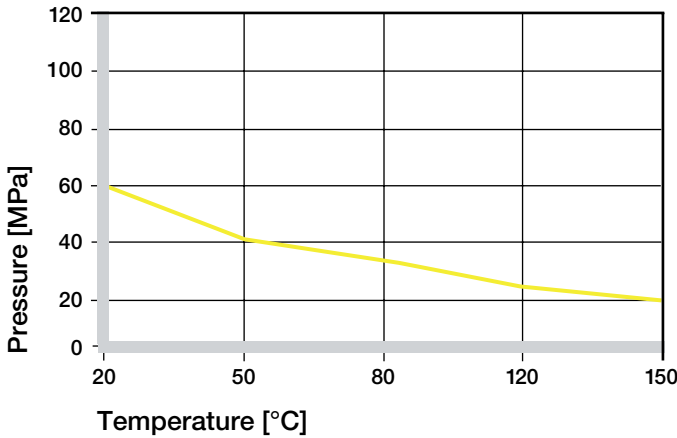

Graph 02: Recommended maximum surface pressure as a function of temperature (35 MPa at +20 °C)

iglidur® W300 gives excellent wear resistance, even in harsh environments or when used with rough shafts. This material is the most tolerant of these external effects out of all the iglidur® range.

iglidur® W300 exhibits a very high compression resistance in spite of its high elasticity. Graph 03 shows the elastic deformation of iglidur® W300 under radial loading. At the recommended maximum surface pressure of 60 MPa, the deformation at room temperature is less than 3 %.

Below the recommended maximum surface pressure of 60 MPa the deformation at room temperature is virtually zero.

► Surface Speed, [page 43](#)

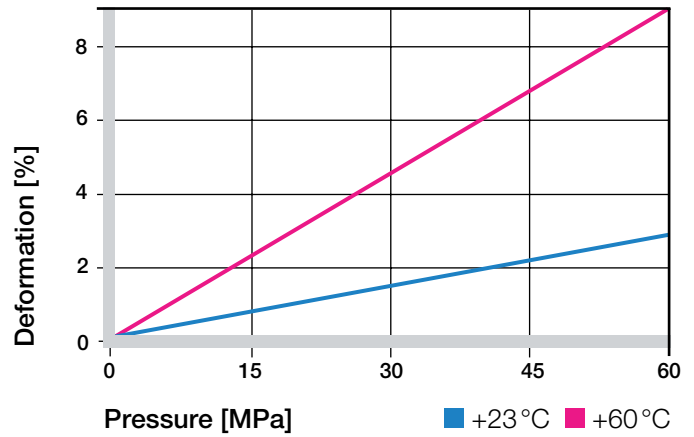

Graph 03: Deformation under pressure and temperature

Permissible Surface Speeds

Even at higher surface speeds, the coefficients of friction for iglidur® W300 do not increase. Therefore, compared to other materials, higher surface speeds can be obtained, for example, up to 1.5 m/s rotating and up to 5 m/s linear. The bearing wear remains low when used for long periods at high speeds, due to exceptional wear resistance. Relatively high speeds can be obtained with iglidur® W300 bearings on hardened shafts with the recommended surface finish.

► Surface Speed, [page 45](#)

m/s	Rotating	Oscillating	Linear
Continuous	1	0.7	4
Short term	2.5	1.8	6

Table 02: Maximum surface speeds

Temperatures

iglidur® W300 plain bearings show minimal reaction to environmental effects. This also applies to temperatures. iglidur® W300 bearings maintain their exceptional wear resistance even up to the highest permissible application temperatures and at the same time resist becoming brittle at low temperatures.

► Application Temperatures, [page 46](#)

iglidur® W300	Application temperature
Minimum	-40 °C
Max. long term	+90 °C
Max. short term	+180 °C
Add. securing is required from	+60 °C

Table 03: Temperature limits

Friction and Wear

Similar to wear resistance, the coefficient of friction μ also changes with the load. In contrast to other iglidur® materials, the coefficient of friction of iglidur® W300 remains consistently low at higher rotational speeds.

► Coefficients of Friction and Surfaces, **page 48**

► Wear Resistance, **page 49**

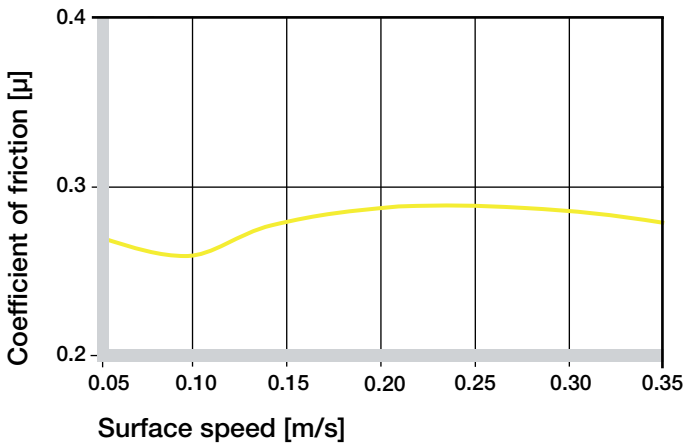

Graph 04: Coefficient of friction as a function of the running speed, $p = 0.75 \text{ MPa}$

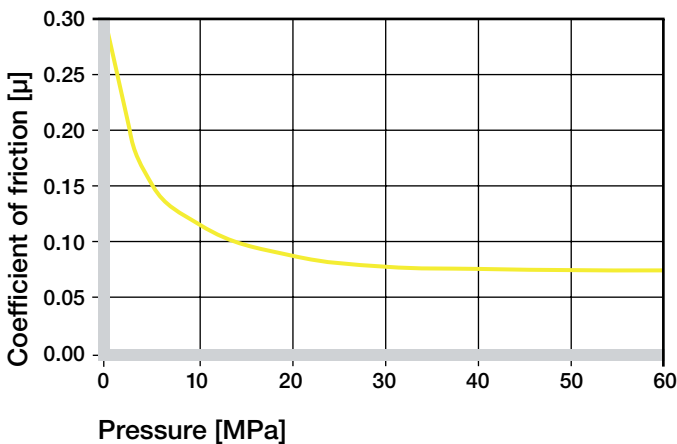

Graph 05: Coefficient of friction as a function of the pressure, $v = 0.01 \text{ m/s}$

Shaft Materials

Friction and wear are to a large extent also highly dependant on the shaft materials. Shafts that are too smooth increase both the coefficient of friction and the wear of the bearing. Smooth shafts have the danger of stick slip. Squeaking as an effect of stick slip is usually the result of shafts that are too smooth.

For the lowest coefficients of friction when using iglidur® W300 plain bearings, the surfaces should not be too smooth. Shaft roughnesses of 0.4 to $0.5 \mu\text{m}$ have proven to be the best (see Graph 06). Tests with iglidur® W300 have shown the wear resistance at this roughness is very high, while the friction reduces to the lowest value.

Graphs 07 to 09 show results of testing different shaft materials with iglidur® W300 plain bearings. For rotational applications with low loads, the wear varies according to the shaft material. iglidur® W300 provides very good to acceptable coefficients of friction for all shafts that were tested. iglidur® W300 gives best results when running on hard shafts. For small radial loads with hard chromed shafts and/or shafts made of stainless steel, iglidur® W300 is the most suitable iglidur® material. The soft shaft materials HR carbon steel and free-machining steel are not as well suited to iglidur® W300 plain bearings. Hardened shafts are preferred for applications for higher loads. Graph 08 clearly shows the difference in materials for increasing loads. A similar picture emerges for oscillating applications. First, for low loads, the wear for the oscillating movement lies below that of a rotation at the same load.

For higher loads, the situation changes. If the shaft material you plan to use is not contained in this list, please contact us.

► Shaft Materials, **page 51**

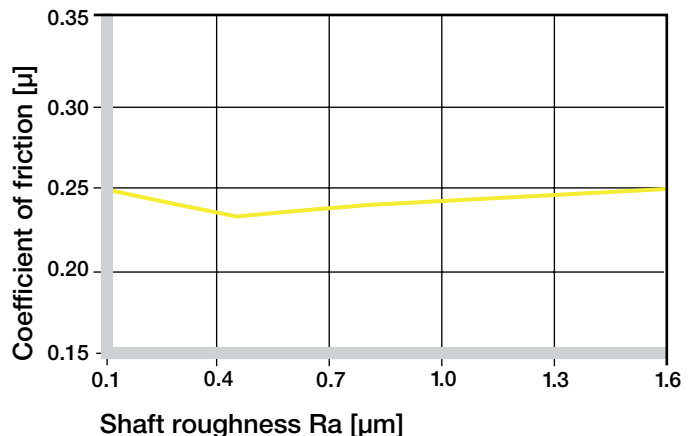

Graph 06: Coefficient of friction as function of the shaft surface (Cf53 hardened and ground steel)

iglidur® W300 | Technical Data

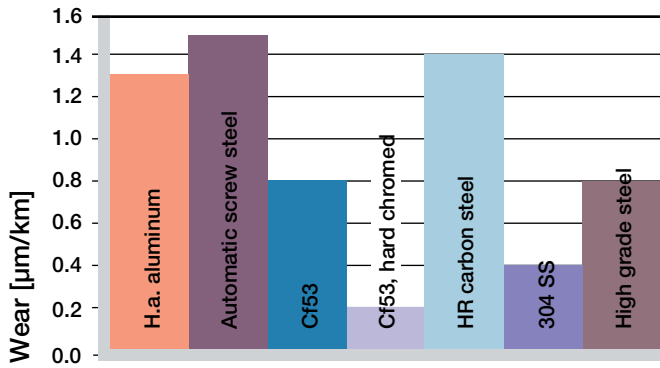

Graph 07: Wear, rotating application with different shaft materials, $p = 0.75 \text{ MPa}$, $v = 0.5 \text{ m/s}$

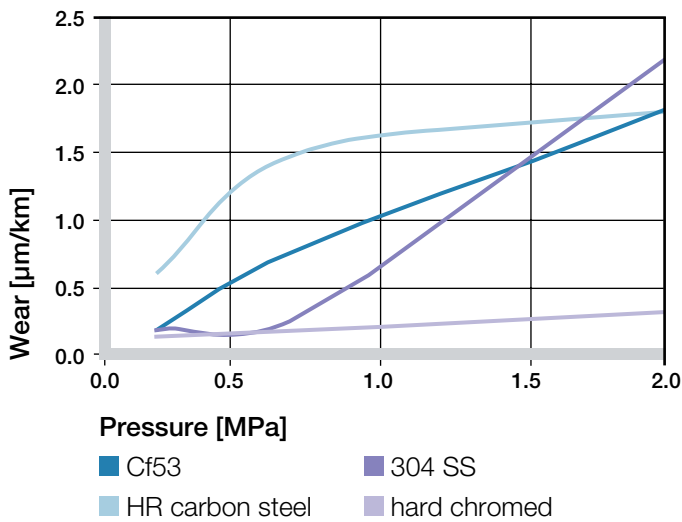

Graph 08: Wear with different shaft materials in rotational operation, as a function of the pressure

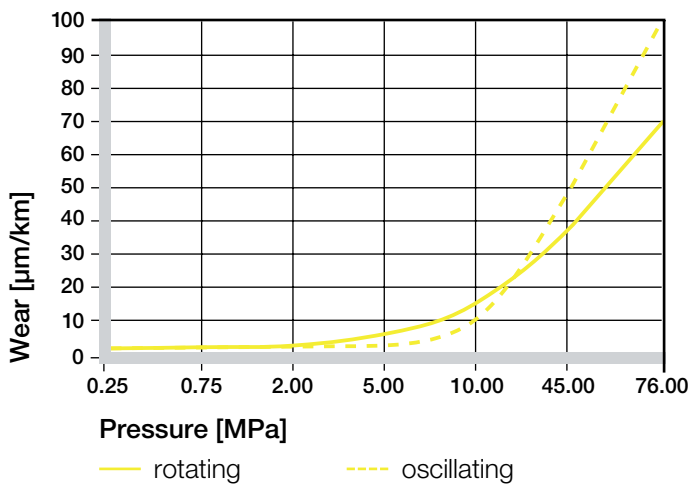

Graph 09: Wear for oscillating and rotating applications with Cf53 hardened and ground steel shafts, as a function of the pressure

iglidur® W300	Dry	Greases	Oil	Water
C.o.f. μ	0,08–0,23	0,09	0,04	0,04

Table 04: Coefficient of friction against steel ($R_a = 1 \text{ }\mu\text{m}$, 50 HRC)

Additional Properties

Chemical Resistance

iglidur® W300 plain bearings have a good resistance to chemicals. They are resistant to most lubricants. iglidur® W300 is not attacked by most weak organic or inorganic acids.

► Chemical Table, page 974

Medium	Resistance
Alkohole	+ to 0
Hydrocarbons	+
Greases, oils without additives	+
Fuels	+
Diluted acids	0 to –
Strong acids	–
Diluted alkalines	+
Strong alkalines	0

+ resistant 0 conditionally resistant – not resistant
All data given at room temperature [$+20 \text{ }^\circ\text{C}$]

Table 05: Chemical resistance

Radiation Resistance

Plain bearings made from iglidur® W300 are resistant to radiation up to an intensity of $3 \cdot 10^2 \text{ Gy}$.

UV Resistance

iglidur® W300 plain bearings are permanently resistant to UV radiation. A slight change in colour (dark coloration) due to UV radiation and other weathering effects will not significantly influence the mechanical, electrical or thermal properties.

Vacuum

In a vacuum, iglidur® W300 plain bearings will outgas any moisture that may have been absorbed. The use of iglidur® W300 in a vacuum environment is only possible to a limited extent.

Electrical Properties

iglidur® W300 plain bearings are electrically insulating.

Specific volume resistance	> 10 ¹³ Ωcm
Surface resistance	> 10 ¹² Ω

Moisture Absorption

The moisture absorption of iglidur® W300 plain bearings is approximately 1.3% weight in the standard atmosphere. The maximum water absorption is 6.5%. This must be taken into account along with other environmental influences.

Maximum moisture absorption

At +23°C/50% r.h.	1.3% weight
Max. moisture absorption	6.5% weight

Table 06: Moisture absorption

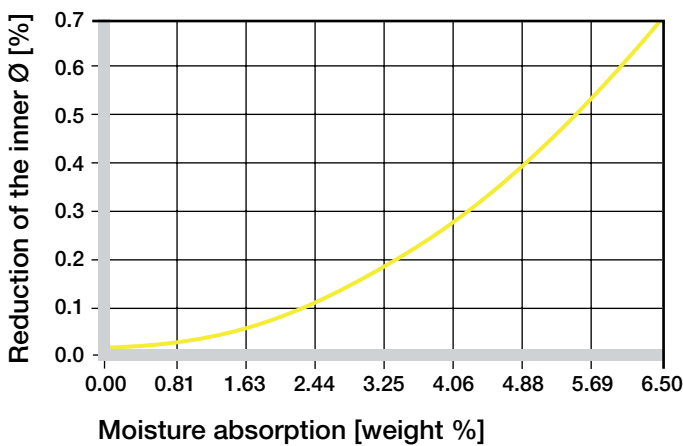

Graph 10: Effect of moisture absorption on plain bearings

Installation Tolerances

iglidur® W300 plain bearings are meant to be oversized before pressfit. The bearings are designed for pressfit into a housing machined to a H7 tolerance. After being assembled into a nominal size housing, the inner diameter adjusts to meet the specified tolerances.

► Testing Methods, page 55

Diameter d1 [mm]	Shaft h9 [mm]	iglidur® W300 E10 [mm]	Housing H7 [mm]
up to 3	0-0.025	+0.014 +0.054	0 +0.010
> 3 to 6	0-0.030	+0.020 +0.068	0 +0.012
> 6 to 10	0-0.036	+0.025 +0.083	0 +0.015
> 10 to 18	0-0.043	+0.032 +0.102	0 +0.018
> 18 to 30	0-0.052	+0.040 +0.124	0 +0.021
> 30 to 50	0-0.062	+0.050 +0.150	0 +0.025
> 50 to 80	0-0.074	+0.060 +0.180	0 +0.030
> 80 to 120	0-0.087	+0.072 +0.212	0 +0.035
> 120 to 180	0-0.100	+0.085 +0.245	0 +0.040

Table 07: Essential tolerances for plain bearings according to ISO 3547-1 after pressfit

iglidur® W300 | Product Range

Sleeve bearing

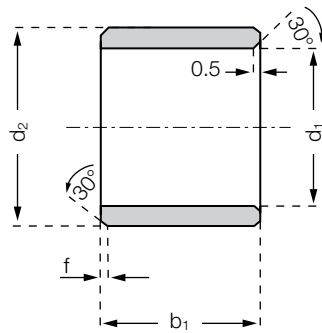

Order key

WSM-0203-03



- Length b1
- Outer diameter d2
- Inner diameter d1
- Metric
- Type (Form S)
- Material iglidur® G

Dimensions according to ISO 3547-1 and special dimensions

Chamfer in relation to the d1

d1 [mm]:	Ø 1-6	Ø 6-12	Ø 12-30	Ø > 30
f [mm]:	0.3	0.5	0.8	1.2

Dimensions [mm]

Part number	d1	d1-Tolerance*	d2	b1 h13
WSM-0203-03	2.0	+0.014 +0.054	3.5	3.0
WSM-0204-03	2.5	+0.014 +0.054	4.0	3.0
WSM-0304-03	3.0	+0.014 +0.054	4.5	3.0
WSM-0304-05	3.0	+0.014 +0.054	4.5	5.0
WSM-0304-06	3.0	+0.014 +0.054	4.5	6.0
WSM-0405-04	4.0	+0.020 +0.068	5.5	4.0
WSM-0405-06	4.0	+0.020 +0.068	5.5	6.0
WSM-0405-08	4.0	+0.020 +0.068	5.5	8.0
WSM-0405-10	4.0	+0.020 +0.068	5.5	10.0
WSM-0507-05	5.0	+0.020 +0.068	7.0	5.0
WSM-0507-08	5.0	+0.020 +0.068	7.0	8.0
WSM-0507-10	5.0	+0.020 +0.068	7.0	10.0
WSM-0608-06	6.0	+0.020 +0.068	8.0	6.0
WSM-0608-08	6.0	+0.020 +0.068	8.0	8.0
WSM-0608-09	6.0	+0.020 +0.068	8.0	9.5
WSM-0608-10	6.0	+0.020 +0.068	8.0	10.0
WSM-0608-11	6.0	+0.020 +0.068	8.0	11.8
WSM-0608-13	6.0	+0.020 +0.068	8.0	13.8
WSM-0709-09	7.0	+0.025 +0.083	9.0	9.0
WSM-0709-12	7.0	+0.025 +0.083	9.0	12.0
WSM-0709-125	7.0	+0.025 +0.083	9.0	12.5
WSM-0810-06	8.0	+0.025 +0.083	10.0	6.0
WSM-0810-08	8.0	+0.025 +0.083	10.0	8.0
WSM-0810-10	8.0	+0.025 +0.083	10.0	10.0
WSM-0810-12	8.0	+0.025 +0.083	10.0	12.0

Part number	d1	d1-Tolerance*	d2	b1 h13
WSM-0810-13	8.0	+0.025 +0.083	10.0	13.8
WSM-0810-15	8.0	+0.025 +0.083	10.0	15.0
WSM-0810-16	8.0	+0.025 +0.083	10.0	16.0
WSM-0810-20	8.0	+0.025 +0.083	10.0	20.0
WSM-0810-21	8.0	+0.025 +0.083	10.0	21.0
WSM-0911-06	9.0	+0.025 +0.083	11.0	6.0
WSM-1012-04	10.0	+0.025 +0.083	12.0	4.0
WSM-1012-06	10.0	+0.025 +0.083	12.0	6.0
WSM-1012-08	10.0	+0.025 +0.083	12.0	8.0
WSM-1012-09	10.0	+0.025 +0.083	12.0	9.0
WSM-1012-10	10.0	+0.025 +0.083	12.0	10.0
WSM-1012-12	10.0	+0.025 +0.083	12.0	12.0
WSM-1012-15	10.0	+0.025 +0.083	12.0	15.0
WSM-1012-17	10.0	+0.025 +0.083	12.0	17.0
WSM-1012-20	10.0	+0.025 +0.083	12.0	20.0
WSM-1012-25.5	10.0	+0.025 +0.083	12.0	25.5
WSM-1113-08	11.0	+0.032 +0.102	13.0	8.0
WSM-1214-04	12.0	+0.032 +0.102	14.0	4.0
WSM-1214-05	12.0	+0.032 +0.102	14.0	5.0
WSM-1214-06	12.0	+0.032 +0.102	14.0	6.0
WSM-1214-08	12.0	+0.032 +0.102	14.0	8.0
WSM-1214-10	12.0	+0.032 +0.102	14.0	10.0
WSM-1214-12	12.0	+0.032 +0.102	14.0	12.0
WSM-1214-15	12.0	+0.032 +0.102	14.0	15.0
WSM-1214-20	12.0	+0.032 +0.102	14.0	20.0

* after pressfit. Testing methods ► page 55



delivery available
time from stock



prices price list online
www.igus.eu/eu/w300



order part number
example WSM-0203-03



Sleeve bearing

Dimensions [mm]

Part number	d1	d1-Tolerance*	d2	b1 h13
WSM-1214-25	12.0	+0.032 +0.102	14.0	25.0
WSM-1315-07	13.0	+0.032 +0.102	15.0	7.0
WSM-1315-10	13.0	+0.032 +0.102	15.0	10.0
WSM-1315-15	13.0	+0.032 +0.102	15.0	15.0
WSM-1315-20	13.0	+0.032 +0.102	15.0	20.0
WSM-1416-07	14.0	+0.032 +0.102	16.0	7.25
WSM-1416-10	14.0	+0.032 +0.102	16.0	10.0
WSM-1416-15	14.0	+0.032 +0.102	16.0	15.0
WSM-1416-20	14.0	+0.032 +0.102	16.0	20.0
WSM-1416-25	14.0	+0.032 +0.102	16.0	25.0
WSM-1416-33	14.0	+0.032 +0.102	16.0	33.0
WSM-1517-10	15.0	+0.032 +0.102	17.0	10.0
WSM-1517-15	15.0	+0.032 +0.102	17.0	15.0
WSM-1517-20	15.0	+0.032 +0.102	17.0	20.0
WSM-1517-25	15.0	+0.032 +0.102	17.0	25.0
WSM-1618-07	16.0	+0.032 +0.102	18.0	7.0
WSM-1618-08	16.0	+0.032 +0.102	18.0	8.0
WSM-1618-11	16.0	+0.032 +0.102	18.0	11.5
WSM-1618-12	16.0	+0.032 +0.102	18.0	12.0
WSM-1618-15	16.0	+0.032 +0.102	18.0	15.0
WSM-1618-20	16.0	+0.032 +0.102	18.0	20.0
WSM-1618-25	16.0	+0.032 +0.102	18.0	25.0
WSM-1820-12	18.0	+0.032 +0.102	20.0	12.0
WSM-1820-15	18.0	+0.032 +0.102	20.0	15.0
WSM-1820-20	18.0	+0.032 +0.102	20.0	20.0
WSM-1820-25	18.0	+0.032 +0.102	20.0	25.0
WSM-1820-33	18.0	+0.032 +0.102	20.0	33.0
WSM-1820-35	18.0	+0.032 +0.102	20.0	35.0
WSM-1922-28	19.0	+0.040 +0.124	22.0	28.0
WSM-2022-11	20.0	+0.040 +0.124	22.0	11.5
WSM-2022-12	20.0	+0.040 +0.124	22.0	12.0
WSM-2022-15	20.0	+0.040 +0.124	22.0	15.0
WSM-2022-20	20.0	+0.040 +0.124	22.0	20.0
WSM-2022-30	20.0	+0.040 +0.124	22.0	30.0
WSM-2023-08	20.0	+0.040 +0.124	23.0	8.0
WSM-2023-12	20.0	+0.040 +0.124	23.0	12.0
WSM-2023-15	20.0	+0.040 +0.124	23.0	15.0
WSM-2023-20	20.0	+0.040 +0.124	23.0	20.0
WSM-2023-23	20.0	+0.040 +0.124	23.0	23.0
WSM-2023-25	20.0	+0.040 +0.124	23.0	25.0
WSM-2023-30	20.0	+0.040 +0.124	23.0	30.0
WSM-2224-15	22.0	+0.040 +0.124	24.0	15.0

Part number	d1	d1-Tolerance*	d2	b1 h13
WSM-2224-20	22.0	+0.040 +0.124	24.0	20.0
WSM-2224-30	22.0	+0.040 +0.124	24.0	30.0
WSM-2224-35	22.0	+0.040 +0.124	24.0	35.0
WSM-2225-15	22.0	+0.040 +0.124	25.0	15.0
WSM-2225-20	22.0	+0.040 +0.124	25.0	20.0
WSM-2225-25	22.0	+0.040 +0.124	25.0	25.0
WSM-2225-30	22.0	+0.040 +0.124	25.0	30.0
WSM-2427-15	24.0	+0.040 +0.124	27.0	15.0
WSM-2427-20	24.0	+0.040 +0.124	27.0	20.0
WSM-2427-25	24.0	+0.040 +0.124	27.0	25.0
WSM-2427-30	24.0	+0.040 +0.124	27.0	30.0
WSM-2528-12	25.0	+0.040 +0.124	28.0	12.0
WSM-2528-14	25.0	+0.040 +0.124	28.0	14.0
WSM-2528-15	25.0	+0.040 +0.124	28.0	15.0
WSM-2528-20	25.0	+0.040 +0.124	28.0	20.0
WSM-2528-25	25.0	+0.040 +0.124	28.0	25.0
WSM-2528-30	25.0	+0.040 +0.124	28.0	30.0
WSM-2630-16	26.0	+0.040 +0.124	30.0	16.0
WSM-2630-25	26.0	+0.040 +0.124	30.0	25.0
WSM-2830-10	28.0	+0.040 +0.124	30.0	10.0
WSM-2831-10	28.0	+0.040 +0.124	31.0	10.0
WSM-2832-20	28.0	+0.040 +0.124	32.0	20.0
WSM-2832-25	28.0	+0.040 +0.124	32.0	25.0
WSM-2832-30	28.0	+0.040 +0.124	32.0	30.0
WSM-3034-16	30.0	+0.040 +0.124	34.0	16.0
WSM-3034-20	30.0	+0.040 +0.124	34.0	20.0
WSM-3034-24	30.0	+0.040 +0.124	34.0	24.0
WSM-3034-25	30.0	+0.040 +0.124	34.0	25.0
WSM-3034-30	30.0	+0.040 +0.124	34.0	30.0
WSM-3034-36	30.0	+0.040 +0.124	34.0	36.0
WSM-3034-38	30.0	+0.040 +0.124	34.0	38.0
WSM-3034-40	30.0	+0.040 +0.124	34.0	40.0
WSM-3034-45	30.0	+0.040 +0.124	34.0	45.0
WSM-3236-20	32.0	+0.050 +0.150	36.0	20.0
WSM-3236-25	32.0	+0.050 +0.150	36.0	25.0
WSM-3236-30	32.0	+0.050 +0.150	36.0	30.0
WSM-3236-40	32.0	+0.050 +0.150	36.0	40.0
WSM-3539-20	35.0	+0.050 +0.150	39.0	20.0
WSM-3539-30	35.0	+0.050 +0.150	39.0	30.0
WSM-3539-40	35.0	+0.050 +0.150	39.0	40.0
WSM-3539-50	35.0	+0.050 +0.150	39.0	50.0
WSM-3540-07	35.0	+0.050 +0.150	40.0	7.0

* after pressfit. Testing methods ► page 55



Sleeve bearing

Dimensions [mm]

Part number	d1	d1-Tolerance*		d2	b1 h13
WSM-4044-20	40.0	+0.050	+0.150	44.0	20.0
WSM-4044-30	40.0	+0.050	+0.150	44.0	30.0
WSM-4044-40	40.0	+0.050	+0.150	44.0	40.0
WSM-4044-50	40.0	+0.050	+0.150	44.0	50.0
WSM-4550-30	45.0	+0.050	+0.150	50.0	30.0
WSM-4550-50	45.0	+0.050	+0.150	50.0	50.0
WSM-5055-20	50.0	+0.050	+0.150	55.0	20.0
WSM-5055-30	50.0	+0.050	+0.150	55.0	30.0
WSM-5055-40	50.0	+0.050	+0.150	55.0	40.0
WSM-5055-50	50.0	+0.050	+0.150	55.0	50.0

Part number	d1	d1-Tolerance*		d2	b1 h13
WSM-5560-40	55.0	+0.060	+0.180	60.0	40.0
WSM-5560-60	55.0	+0.060	+0.180	60.0	60.0
WSM-6065-30	60.0	+0.060	+0.180	65.0	30.0
WSM-6065-60	60.0	+0.060	+0.180	65.0	60.0
WSM-6570-60	65.0	+0.060	+0.180	70.0	60.0
WSM-7075-60	70.0	+0.060	+0.180	75.0	60.0
WSM-8085-100	80.0	+0.060	+0.180	85.0	100.0
WSM-9095-100	90.0	+0.072	+0.212	95.0	100.0
WSM-100105-100	100.0	+0.072	+0.212	105.0	100.0

* after pressfit. Testing methods ► page 55



delivery available
time from stock



prices price list online
www.igus.eu/eu/w300



order part number
example WSM-4044-20

Flange bearing

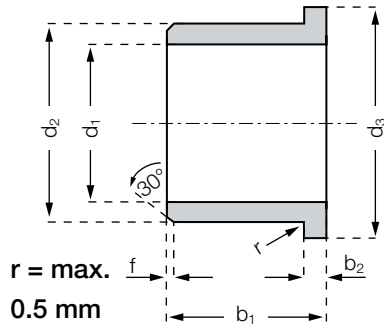

Order key

WFM-0304-03



Length b1
Outer diameter d2
Inner diameter d1
Metric
Type (Form F)
Material iglidur® G

Dimensions according to ISO 3547-1 and special dimensions

Chamfer in relation to the d1

d1 [mm]:	Ø 1-6	Ø 6-12	Ø 12-30	Ø > 30
f [mm]:	0.3	0.5	0.8	1.2

Dimensions [mm]

Part number	d1	d1-Tolerance*	d2	d3 d13	b1 h13	b2 -0.14
WFM-0304-03	3.0	+0.014 +0.054	4.5	7.5	3.0	0.75
WFM-0304-05	3.0	+0.014 +0.054	4.5	7.5	5.0	0.75
WFM-0405-03	4.0	+0.020 +0.068	5.5	9.5	3.0	0.75
WFM-0405-04	4.0	+0.020 +0.068	5.5	9.5	4.0	0.75
WFM-0405-06	4.0	+0.020 +0.068	5.5	9.5	6.0	0.75
WFM-0506-08	5.0	+0.010 +0.040	6.0	10.0	8.0	0.50
WFM-0507-04	5.0	+0.020 +0.068	7.0	11.0	4.0	1.00
WFM-0507-05	5.0	+0.020 +0.068	7.0	11.0	5.0	1.00
WFM-0608-04	6.0	+0.020 +0.068	8.0	12.0	4.0	1.00
WFM-0608-06	6.0	+0.020 +0.068	8.0	12.0	6.0	1.00
WFM-0608-08	6.0	+0.020 +0.068	8.0	12.0	8.0	1.00
WFM-0608-10	6.0	+0.020 +0.068	8.0	12.0	10.0	1.00
WFM-0608-15	6.0	+0.020 +0.068	8.0	12.0	15.0	1.00
WFM-0709-12	7.0	+0.025 +0.083	9.0	15.0	12.0	1.00
WFM-0810-02	8.0	+0.025 +0.083	10.0	15.0	2.7	1.00
WFM-0810-05	8.0	+0.025 +0.083	10.0	15.0	5.5	1.00
WFM-0810-07	8.0	+0.025 +0.083	10.0	15.0	7.5	1.00
WFM-0810-09	8.0	+0.025 +0.083	10.0	15.0	9.5	1.00
WFM-0810-10	8.0	+0.025 +0.083	10.0	15.0	10.0	1.00
WFM-0810-23	8.0	+0.025 +0.083	10.0	15.0	23.0	1.00
WFM-0810-30	8.0	+0.025 +0.083	10.0	15.0	30.0	1.00
WFM-081015-05	8.0	+0.025 +0.083	10.0	15.0	5.0	1.00
WFM-1012-04	10.0	+0.025 +0.083	12.0	18.0	4.0	1.00
WFM-1012-05	10.0	+0.025 +0.083	12.0	18.0	5.0	1.00
WFM-1012-06	10.0	+0.025 +0.083	12.0	18.0	6.0	1.00

* after pressfit. Testing methods ► page 55



delivery available
time from stock



prices price list online
www.igus.eu/eu/w300



order part number
example WFM-0304-03



Flange bearing

Dimensions [mm]

Part number	d1	d1-Tolerance*	d2	d3 d13	b1 h13	b2 -0.14
WFM-1012-07	10.0	+0.025 +0.083	12.0	18.0	7.0	1.00
WFM-1012-09	10.0	+0.025 +0.083	12.0	18.0	9.0	1.00
WFM-1012-10	10.0	+0.025 +0.083	12.0	18.0	10.0	1.00
WFM-1012-12	10.0	+0.025 +0.083	12.0	18.0	12.0	1.00
WFM-1012-15	10.0	+0.025 +0.083	12.0	18.0	15.0	1.00
WFM-1012-17	10.0	+0.025 +0.083	12.0	18.0	17.0	1.00
WFM-1214-04	12.0	+0.032 +0.102	14.0	20.0	4.0	1.00
WFM-1214-044	12.0	+0.032 +0.102	14.0	20.0	4.4	1.00
WFM-1214-06	12.0	+0.032 +0.102	14.0	20.0	6.0	1.00
WFM-1214-07	12.0	+0.032 +0.102	14.0	20.0	7.0	1.00
WFM-1214-09	12.0	+0.032 +0.102	14.0	20.0	9.0	1.00
WFM-1214-10	12.0	+0.032 +0.102	14.0	20.0	10.0	1.00
WFM-1214-11	12.0	+0.032 +0.102	14.0	20.0	11.0	1.00
WFM-1214-12	12.0	+0.032 +0.102	14.0	20.0	12.0	1.00
WFM-1214-15	12.0	+0.032 +0.102	14.0	20.0	15.0	1.00
WFM-1214-17	12.0	+0.032 +0.102	14.0	20.0	17.0	1.00
WFM-1214-20	12.0	+0.032 +0.102	14.0	20.0	20.0	1.00
WFM-1315-06	13.0	+0.032 +0.102	15.0	22.0	6.0	1.00
WFM-1416-04	14.0	+0.032 +0.102	16.0	22.0	4.0	1.00
WFM-1416-05	14.0	+0.032 +0.102	16.0	22.0	5.0	1.00
WFM-1416-08	14.0	+0.032 +0.102	16.0	22.0	8.0	1.00
WFM-1416-12	14.0	+0.032 +0.102	16.0	22.0	12.0	1.00
WFM-1416-17	14.0	+0.032 +0.102	16.0	22.0	17.0	1.00
WFM-1416-29	14.0	+0.032 +0.102	16.0	22.0	29.0	1.00
WFM-1517-09	15.0	+0.032 +0.102	17.0	23.0	9.0	1.00
WFM-1517-12	15.0	+0.032 +0.102	17.0	23.0	12.0	1.00
WFM-1517-17	15.0	+0.032 +0.102	17.0	23.0	17.0	1.00
WFM-1517-20	15.0	+0.032 +0.102	17.0	23.0	20.0	1.00
WFM-1618-09	16.0	+0.032 +0.102	18.0	24.0	9.0	1.00
WFM-1618-12	16.0	+0.032 +0.102	18.0	24.0	12.0	1.00
WFM-1618-17	16.0	+0.032 +0.102	18.0	24.0	17.0	1.00
WFM-1719-12	17.0	+0.032 +0.102	19.0	25.0	12.0	1.00
WFM-1719-18	17.0	+0.032 +0.102	19.0	25.0	18.0	1.00
WFM-1719-25	17.0	+0.032 +0.102	19.0	25.0	25.0	1.00
WFM-1820-12	18.0	+0.032 +0.102	20.0	26.0	12.0	1.00
WFM-1820-17	18.0	+0.032 +0.102	20.0	26.0	17.0	1.00
WFM-1820-22	18.0	+0.032 +0.102	20.0	26.0	22.0	1.00
WFM-2023-11	20.0	+0.040 +0.124	23.0	30.0	11.5	1.50
WFM-2023-14	20.0	+0.040 +0.124	23.0	30.0	14.0	1.50
WFM-2023-16	20.0	+0.040 +0.124	23.0	30.0	16.5	1.50
WFM-2023-21	20.0	+0.040 +0.124	23.0	30.0	21.5	1.50
WFM-2427-10	24.0	+0.040 +0.124	27.0	32.0	10.0	1.50

* after pressfit. Testing methods ► page 55



Flange bearing

Dimensions [mm]

Part number	d1	d1-Tolerance*	d2	d3 d13	b1 h13	b2 -0.14
WFM-2528-11	25.0	+0.040 +0.124	28.0	35.0	11.0	1.50
WFM-2528-16	25.0	+0.040 +0.124	28.0	35.0	16.0	1.50
WFM-2528-21	25.0	+0.040 +0.124	28.0	35.0	21.0	1.50
WFM-2528-30	25.0	+0.040 +0.124	28.0	32.0	30.0	1.50
WFM-252831-13	25.0	+0.040 +0.124	28.0	31.0	13.0	1.50
WFM-2830-36	28.0	+0.040 +0.124	30.0	35.0	36.0	1.00
WFM-3034-10	30.0	+0.040 +0.124	34.0	42.0	10.0	2.00
WFM-3034-16	30.0	+0.040 +0.124	34.0	42.0	16.0	2.00
WFM-3034-26	30.0	+0.040 +0.124	34.0	42.0	26.0	2.00
WFM-3034-37	30.0	+0.040 +0.124	34.0	42.0	37.0	2.00
WFM-3236-16	32.0	+0.050 +0.150	36.0	40.0	16.0	2.00
WFM-3236-26	32.0	+0.050 +0.150	36.0	40.0	26.0	2.00
WFM-3539-16	35.0	+0.050 +0.150	39.0	47.0	16.0	2.00
WFM-3539-26	35.0	+0.050 +0.150	39.0	47.0	26.0	2.00
WFM-353950-35	35.0	+0.050 +0.150	39.0	50.0	35.0	2.00
WFM-3842-22	38.0	+0.050 +0.150	42.0	50.0	22.0	2.00
WFM-4044-30	40.0	+0.050 +0.150	44.0	52.0	30.0	2.00
WFM-4044-40	40.0	+0.050 +0.150	44.0	52.0	40.0	2.00
WFM-4550-50	45.0	+0.050 +0.150	50.0	58.0	50.0	2.00
WFM-5055-40	50.0	+0.050 +0.150	55.0	63.0	40.0	2.00
WFM-5055-50	50.0	+0.050 +0.150	55.0	63.0	50.0	2.00
WFM-5560-60	55.0	+0.060 +0.180	60.0	68.0	60.0	2.00
WFM-5762-40	57.0	+0.060 +0.180	62.0	67.0	40.0	2.00
WFM-6065-60	60.0	+0.060 +0.180	65.0	73.0	60.0	2.00
WFM-6570-60	65.0	+0.060 +0.180	70.0	78.0	60.0	2.00
WFM-7075-100	70.0	+0.060 +0.180	75.0	83.0	100.0	2.50
WFM-7580-100	75.0	+0.060 +0.180	80.0	88.0	100.0	2.50
WFM-8085-100	80.0	+0.060 +0.180	85.0	93.0	100.0	2.50
WFM-9095-100	90.0	+0.072 +0.212	95.0	103.0	100.0	2.50
WFM-100105-100	100.0	+0.072 +0.212	105.0	113.0	100.0	2.50
WFM-120125-100	120.0	+0.072 +0.212	125.0	133.0	100.0	2.50

* after pressfit. Testing methods ► page 55

Thrust washer

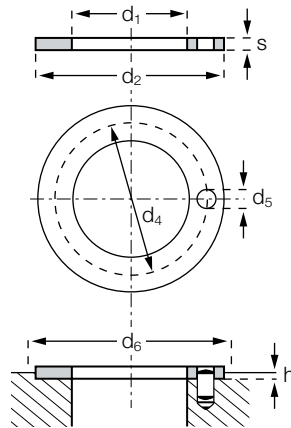
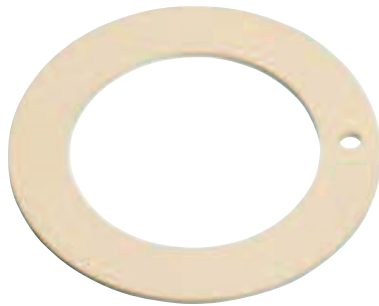

Order key

WTM-0509-006



Thickness s
Outer diameter d2
Inner diameter d1
Metric
Type (Form T)
Material iglidur® G

Dimensions according to ISO 3547-1 and special dimensions

Dimensions [mm]

Part number	d1 +0.25	d2 -0.25	s -0.05	d4 -0.12 +0.12	d5 +0.375 +0.125	h +0.2 -0.2	d6 +0.12
WTM-0509-006	5.0	9.5	0.6	**	**	0.3	9.5
WTM-0620-015	6.0	20.0	1.5	13.0	1.5	1.0	20.0
WTM-0818-015	8.0	18.0	1.5	13.0	1.5	1.0	18.0
WTM-1018-010	10.0	18.0	1.0	**	**	0.7	18.0
WTM-1018-015	10.0	18.0	1.5	**	**	1.0	18.0
WTM-1224-015	12.0	24.0	1.5	18.0	1.5	1.0	24.0
WTM-1426-015	14.0	26.0	1.5	20.0	2.0	1.0	26.0
WTM-1524-015	15.0	24.0	1.5	19.5	1.5	1.0	24.0
WTM-1630-015	16.0	30.0	1.5	23.0	2.0	1.0	30.0
WTM-1832-015	18.0	32.0	1.5	25.0	2.0	1.0	32.0
WTM-2036-015	20.0	36.0	1.5	28.0	3.0	1.0	36.0
WTM-2238-015	22.0	38.0	1.5	30.0	3.0	1.0	38.0
WTM-2442-015	24.0	42.0	1.5	33.0	3.0	1.0	42.0
WTM-2644-015	26.0	44.0	1.5	35.0	3.0	1.0	44.0
WTM-2848-015	28.0	48.0	1.5	38.0	4.0	1.0	48.0
WTM-3254-015	32.0	54.0	1.5	43.0	4.0	1.0	54.0
WTM-3862-015	38.0	62.0	1.5	50.0	4.0	1.0	62.0
WTM-4266-015	42.0	66.0	1.5	54.0	4.0	1.0	66.0
WTM-4874-020	48.0	74.0	2.0	61.0	4.0	1.5	74.0
WTM-5278-020	52.0	78.0	2.0	65.0	4.0	1.5	78.0
WTM-6290-020	62.0	90.0	2.0	76.0	4.0	1.5	90.0
WTM-82110-020	82.0	110.0	2.0	**	**	1.5	110.0
WTM-102130-020	102.0	130.0	2.0	**	**	1.5	130.0
WTM-120150-020	120.0	150.0	2.0	**	**	1.5	150.0

** Design without fixing bore



delivery available
time from stock



prices price list online
www.igus.eu/eu/w300



order part number
example WTM-0509-006

Sleeve bearing

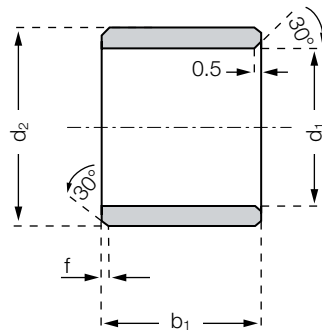

Order key

WSI-0203-03



- Length b1
- Outer diameter d2
- Inner diameter d1
- Inch
- Type (Form S)
- Material iglidur® W300

Chamfer in relation to the d1

d1 [Inch]:	Ø 0,040–0,236	Ø 0,236–0,472	Ø 0,472–1,18	Ø > 1,18
f [Inch]:	0.012	0.019	0.031	0.047

Dimensions [Inch]

Part number	d1	d2	b1	d1*		Housing bore		Shaft size	
				max.	min.	max.	min.	max.	min.
WSI-0203-03	1/8	3/16	3/16	.1269	.1251	.1878	.1873	.1243	.1236
WSI-0203-04	1/8	3/16	1/4	.1269	.1251	.1878	.1873	.1243	.1236
WSI-0203-06	1/8	3/16	3/8	.1269	.1251	.1878	.1873	.1243	.1236
WSI-0304-04	3/16	1/4	1/4	.1892	.1873	.2503	.2497	.1865	.1858
WSI-0304-06	3/16	1/4	3/8	.1892	.1873	.2503	.2497	.1865	.1858
WSI-0304-08	3/16	1/4	1/2	.1892	.1873	.2503	.2497	.1865	.1858
WSI-0405-03	1/4	5/16	3/16	.2521	.2498	.3128	.3122	.2490	.2481
WSI-0405-04	1/4	5/16	1/4	.2521	.2498	.3128	.3122	.2490	.2481
WSI-0405-05	1/4	5/16	5/16	.2521	.2498	.3128	.3122	.2490	.2481
WSI-0405-06	1/4	5/16	3/8	.2521	.2498	.3128	.3122	.2490	.2481
WSI-0405-08	1/4	5/16	1/2	.2521	.2498	.3128	.3122	.2490	.2481
WSI-0506-04	5/16	3/8	1/4	.3148	.3125	.3753	.3747	.3115	.3106
WSI-0506-06	5/16	3/8	3/8	.3148	.3125	.3753	.3747	.3115	.3106
WSI-0506-08	5/16	3/8	1/2	.3148	.3125	.3753	.3747	.3115	.3106
WSI-0506-12	5/16	3/8	3/4	.3148	.3125	.3753	.3747	.3115	.3106
WSI-0607-04	3/8	15/32	1/4	.3773	.3750	.4691	.4684	.3740	.3731
WSI-0607-06	3/8	15/32	3/8	.3773	.3750	.4691	.4684	.3740	.3731
WSI-0607-07	3/8	15/32	7/16	.3773	.3750	.4691	.4684	.3740	.3731
WSI-0607-08	3/8	15/32	1/2	.3773	.3750	.4691	.4684	.3740	.3731
WSI-0607-12	3/8	15/32	3/4	.3773	.3750	.4691	.4684	.3740	.3731
WSI-0608-12	3/8	17/32	3/4	.3773	.3750	.5316	.5309	.3740	.3731
WSI-0708-04	7/16	17/32	1/4	.4406	.4379	.5316	.5309	.4365	.4355
WSI-0708-08	7/16	17/32	1/2	.4406	.4379	.5316	.5309	.4365	.4355
WSI-0809-03	1/2	19/32	3/16	.5030	.5003	.5941	.5934	.4990	.4980
WSI-0809-04	1/2	19/32	1/4	.5030	.5003	.5941	.5934	.4990	.4980

* after pressfit. Testing methods ► page 55



delivery available
time from stock



prices price list online
www.igus.eu/eu/w300



order part number
example WSI-0203-03



Sleeve bearing

Dimensions [Inch]

Part number	d1	d2	b1	d1*		Housing bore		Shaft size	
				max.	min.	max.	min.	max.	min.
WSI-0809-06	1/2	19/32	3/8	.5030	.5003	.5941	.5934	.4990	.4980
WSI-0809-08	1/2	19/32	1/2	.5030	.5003	.5941	.5934	.4990	.4980
WSI-0809-10	1/2	19/32	5/8	.5030	.5003	.5941	.5934	.4990	.4980
WSI-0809-12	1/2	19/32	3/4	.5030	.5003	.5941	.5934	.4990	.4980
WSI-0809-16	1/2	19/32	1	.5030	.5003	.5941	.5934	.4990	.4980
WSI-0810-08	1/2	5/8	1/2	.5040	.5013	.6260	.6250	.5000	.4990
WSI-0810-10	1/2	5/8	5/8	.5040	.5013	.6260	.6250	.5000	.4990
WSI-0810-12	1/2	5/8	3/4	.5040	.5013	.6260	.6250	.5000	.4990
WSI-0810-16	1/2	5/8	1	.5040	.5013	.6260	.6250	.5000	.4990
WSI-0910-08	9/16	5/8	1/2	.5655	.5627	.6566	.6559	.5615	.5605
WSI-0910-12	9/16	5/8	3/4	.5655	.5627	.6566	.6559	.5615	.5605
WSI-1011-04	5/8	23/32	1/4	.6280	.6253	.7192	.7184	.6240	.6230
WSI-1011-06	5/8	23/32	3/8	.6280	.6253	.7192	.7184	.6240	.6230
WSI-1011-08	5/8	23/32	1/2	.6280	.6253	.7192	.7184	.6240	.6230
WSI-1011-10	5/8	23/32	5/8	.6280	.6253	.7192	.7184	.6240	.6230
WSI-1011-12	5/8	23/32	3/4	.6280	.6253	.7192	.7184	.6240	.6230
WSI-1011-16	5/8	23/32	1	.6280	.6253	.7192	.7184	.6240	.6230
WSI-1112-12	11/16	25/32	3/4	.6906	.6879	.7817	.7809	.6865	.6855
WSI-1214-08	3/4	7/8	1/2	.7541	.7507	.8755	.8747	.7491	.7479
WSI-1214-12	3/4	7/8	3/4	.7541	.7507	.8755	.8747	.7491	.7479
WSI-1214-16	3/4	7/8	1	.7541	.7507	.8755	.8747	.7491	.7479
WSI-1214-24	3/4	7/8	1 1/2	.7541	.7507	.8755	.8747	.7491	.7479
WSI-1416-04	7/8	1	1/4	.8791	.8757	1.0005	.9997	.8741	.8729
WSI-1416-06	7/8	1	3/8	.8791	.8757	1.0005	.9997	.8741	.8729
WSI-1416-08	7/8	1	1/2	.8791	.8757	1.0005	.9997	.8741	.8729
WSI-1416-10	7/8	1	5/8	.8791	.8757	1.0005	.9997	.8741	.8729
WSI-1416-12	7/8	1	3/4	.8791	.8757	1.0005	.9997	.8741	.8729
WSI-1416-16	7/8	1	1	.8791	.8757	1.0005	.9997	.8741	.8729
WSI-1416-24	7/8	1	1 1/2	.8791	.8757	1.0005	.9997	.8741	.8729
WSI-1618-06	1	1 1/8	3/8	1.0041	1.0007	1.1255	1.1247	.9991	.9979
WSI-1618-08	1	1 1/8	1/2	1.0041	1.0007	1.1255	1.1247	.9991	.9979
WSI-1618-12	1	1 1/8	3/4	1.0041	1.0007	1.1255	1.1247	.9991	.9979
WSI-1618-16	1	1 1/8	1	1.0041	1.0007	1.1255	1.1247	.9991	.9979
WSI-1618-20	1	1 1/8	1 5/16	1.0041	1.0007	1.1255	1.1247	.9991	.9979
WSI-1618-22	1	1 1/8	1 3/8	1.0041	1.0007	1.1255	1.1247	.9991	.9979
WSI-1618-24	1	1 1/8	1 1/2	1.0041	1.0007	1.1255	1.1247	.9991	.9979
WSI-1820-12	1 1/8	1 9/32	3/4	1.1288	1.1254	1.2818	1.2808	1.1238	1.1226
WSI-2022-14	1 1/4	1 13/32	7/8	1.2548	1.2508	1.4068	1.4058	1.2488	1.2472
WSI-2022-16	1 1/4	1 13/32	1	1.2548	1.2508	1.4068	1.4058	1.2488	1.2472
WSI-2022-20	1 1/4	1 13/32	1 1/4	1.2548	1.2508	1.4068	1.4058	1.2488	1.2472
WSI-2022-24	1 1/4	1 13/32	1 1/2	1.2548	1.2508	1.4068	1.4058	1.2488	1.2472
WSI-2224-16	1 3/8	1 17/32	1	1.3798	1.3758	1.5318	1.5308	1.3738	1.3722

* after pressfit. Testing methods ► page 55



Sleeve bearing

Dimensions [Inch]

Part number	d1	d2	b1	d1*		Housing bore		Shaft size	
				max.	min.	max.	min.	max.	min.
WSI-2224-24	1 3/8	1 17/32	1 1/2	1.3798	1.3758	1.5318	1.5308	1.3738	1.3722
WSI-2426-12	1 1/2	1 21/32	3/4	1.5048	1.5008	1.6568	1.6558	1.4988	1.4972
WSI-2426-16	1 1/2	1 21/32	1	1.5048	1.5008	1.6568	1.6558	1.4988	1.4972
WSI-2426-24	1 1/2	1 21/32	1 1/2	1.5048	1.5008	1.6568	1.6558	1.4988	1.4972
WSI-2426-44	1 1/2	1 21/32	2 3/4	1.5048	1.5008	1.6568	1.6558	1.4988	1.4972
WSI-2629-16	1 5/8	1 25/32	1	1.6297	1.6258	1.7818	1.7808	1.6238	1.6222
WSI-2629-20	1 5/8	1 25/32	1 1/4	1.6297	1.6258	1.7818	1.7808	1.6238	1.6222
WSI-2831-16	1 3/4	1 15/16	1	1.7547	1.7507	1.9381	1.9371	1.7487	1.7471
WSI-2831-24	1 3/4	1 15/16	1 1/2	1.7547	1.7507	1.9381	1.9371	1.7487	1.7471
WSI-2831-32	1 3/4	1 15/16	2	1.7547	1.7507	1.9381	1.9371	1.7487	1.7471
WSI-2831-48	1 3/4	1 15/16	3	1.7547	1.7507	1.9381	1.9371	1.7487	1.7471
WSI-3235-16	2	2 3/16	1	2.0057	2.0011	2.1883	2.1871	1.9981	1.9969
WSI-3235-24	2	2 3/16	1 1/2	2.0057	2.0011	2.1883	2.1871	1.9981	1.9969
WSI-3235-32	2	2 3/16	2	2.0057	2.0011	2.1883	2.1871	1.9981	1.9969
WSI-3639-32	2 1/4	2 7/16	2	2.2577	2.2531	2.4377	2.4365	2.2507	2.2489

* after pressfit. Testing methods ► page 55

Flange bearing

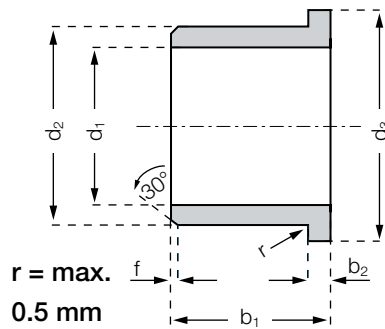

Order key

WFI-0203-03



Length b1
Outer diameter d2
Inner diameter d1
Inch
Type (Form F)
Material iglidur® W300

Chamfer in relation to the d1

d1 [Inch]:	Ø 0,040–0,236	Ø 0,236–0,472	Ø 0,472–1,18	Ø > 1,18
f [Inch]:	0.012	0.019	0.031	0.047

Dimensions [Inch]

Part number	d1	d2	b1	d3	b2	d1*		Housing bore		Shaft size	
						max.	min.	max.	min.	max.	min.
WFI-0203-03	1/8	3/16	3/16	.312	.032	.1269	.1251	.1878	.1873	.1243	.1236
WFI-0203-04	1/8	3/16	1/4	.312	.032	.1269	.1251	.1878	.1873	.1243	.1236
WFI-0203-06	1/8	3/16	3/8	.312	.032	.1269	.1251	.1878	.1873	.1243	.1236
WFI-0304-02	3/16	1/4	1/8	.375	.032	.1892	.1873	.2503	.2497	.1865	.1858
WFI-0304-04	3/16	1/4	1/4	.375	.032	.1892	.1873	.2503	.2497	.1865	.1858
WFI-0304-06	3/16	1/4	3/8	.375	.032	.1892	.1873	.2503	.2497	.1865	.1858
WFI-0304-08	3/16	1/4	1/2	.375	.032	.1892	.1873	.2503	.2497	.1865	.1858
WFI-0405-04	1/4	5/16	1/4	.500	.032	.2521	.2498	.3128	.3122	.2490	.2481
WFI-0405-05	1/4	5/16	5/16	.500	.032	.2521	.2498	.3128	.3122	.2490	.2481
WFI-0405-06	1/4	5/16	3/8	.500	.032	.2521	.2498	.3128	.3122	.2490	.2481
WFI-0405-08	1/4	5/16	1/2	.500	.032	.2521	.2498	.3128	.3122	.2490	.2481
WFI-0405-12	1/4	5/16	3/4	.500	.032	.2521	.2498	.3128	.3122	.2490	.2481
WFI-0506-04	5/16	3/8	1/4	.562	.032	.3148	.3125	.3753	.3747	.3115	.3106
WFI-0506-06	5/16	3/8	3/8	.562	.032	.3148	.3125	.3753	.3747	.3115	.3106
WFI-0506-08	5/16	3/8	1/2	.562	.032	.3148	.3125	.3753	.3747	.3115	.3106
WFI-0506-12	5/16	3/8	3/4	.562	.032	.3148	.3125	.3753	.3747	.3115	.3106
WFI-0607-04	3/8	15/32	1/4	.687	.046	.3773	.3750	.4691	.4684	.3740	.3731
WFI-0607-06	3/8	15/32	3/8	.687	.046	.3773	.3750	.4691	.4684	.3740	.3731
WFI-0607-08	3/8	15/32	1/2	.687	.046	.3773	.3750	.4691	.4684	.3740	.3731
WFI-0607-12	3/8	15/32	3/4	.687	.046	.3773	.3750	.4691	.4684	.3740	.3731
WFI-0708-08	7/16	17/32	1/2	.750	.046	.4406	.4379	.5316	.5309	.4365	.4355
WFI-0809-04	1/2	19/32	1/4	.875	.046	.5030	.5003	.5941	.5934	.4990	.4980
WFI-0809-06	1/2	19/32	3/8	.875	.046	.5030	.5003	.5941	.5934	.4990	.4980
WFI-0809-08	1/2	19/32	1/2	.875	.046	.5030	.5003	.5941	.5934	.4990	.4980
WFI-0809-12	1/2	19/32	3/4	.875	.046	.5030	.5003	.5941	.5934	.4990	.4980

* after pressfit. Testing methods ► page 55



delivery available
time from stock



prices price list online
www.igus.eu/eu/w300



order part number
example WFI-0203-03



Flange bearing

Dimensions [Inch]

Part number	d1	d2	b1	d3	b2	d1*		Housing bore		Shaft aize	
						max.	min.	max.	min.	max.	min.
WFI-0809-16	1/2	19/32	1	.875	.046	.5030	.5003	.5941	.5934	.4990	.4980
WFI-1011-045	5/8	23/32	9/32	.937	.046	.6280	.6253	.7192	.7184	.6240	.6230
WFI-1011-08	5/8	23/32	1/2	.937	.046	.6280	.6253	.7192	.7184	.6240	.6230
WFI-1011-12	5/8	23/32	3/4	.937	.046	.6280	.6253	.7192	.7184	.6240	.6230
WFI-1011-16	5/8	23/32	1	.937	.046	.6280	.6253	.7192	.7184	.6240	.6230
WFI-1011-24	5/8	23/32	1 1/2	.937	.046	.6280	.6253	.7192	.7184	.6240	.6230
WFI-1214-08	3/4	7/8	1/2	1.125	.062	.7541	.7507	.8755	.8747	.7491	.7479
WFI-1214-10	3/4	7/8	5/8	1.125	.062	.7541	.7507	.8755	.8747	.7491	.7479
WFI-1214-12	3/4	7/8	3/4	1.125	.062	.7541	.7507	.8755	.8747	.7491	.7479
WFI-1214-16	3/4	7/8	1	1.125	.062	.7541	.7507	.8755	.8747	.7491	.7479
WFI-1214-24	3/4	7/8	1 1/2	1.125	.062	.7541	.7507	.8755	.8747	.7491	.7479
WFI-1416-04	7/8	1	1/4	1.250	.062	.8791	.8757	1.0005	.9997	.8741	.8729
WFI-1416-075	7/8	1	15/32	1.250	.062	.8791	.8757	1.0005	.9997	.8741	.8729
WFI-1416-08	7/8	1	1/2	1.250	.062	.8791	.8757	1.0005	.9997	.8741	.8729
WFI-1416-115	7/8	1	23/32	1.250	.062	.8791	.8757	1.0005	.9997	.8741	.8729
WFI-1416-12	7/8	1	3/4	1.250	.062	.8791	.8757	1.0005	.9997	.8741	.8729
WFI-1416-16	7/8	1	1	1.250	.062	.8791	.8757	1.0005	.9997	.8741	.8729
WFI-1416-20	7/8	1	1 1/4	1.250	.062	.8791	.8757	1.0005	.9997	.8741	.8729
WFI-1416-24	7/8	1	1 1/2	1.250	.062	.8791	.8757	1.0005	.9997	.8741	.8729
WFI-141618-10	7/8	1	5/8	1.250	.062	.8791	.8757	1.0005	.9997	.8741	.8729
WFI-141620-11	7/8	1	11/16	1.250	.062	.8791	.8757	1.0005	.9997	.8741	.8729
WFI-1618-08	1	1 1/8	1/2	1.375	.062	1.0041	1.0007	1.1255	1.1247	.9991	.9979
WFI-1618-12	1	1 1/8	3/4	1.375	.062	1.0041	1.0007	1.1255	1.1247	.9991	.9979
WFI-1618-16	1	1 1/8	1	1.375	.062	1.0041	1.0007	1.1255	1.1247	.9991	.9979
WFI-1618-20	1	1 1/8	1 1/4	1.375	.062	1.0041	1.0007	1.1255	1.1247	.9991	.9979
WFI-1618-24	1	1 1/8	1 1/2	1.375	.062	1.0041	1.0007	1.1255	1.1247	.9991	.9979
WFI-1820-08	1 1/8	1 9/32	1/2	1.562	.078	1.1288	1.1254	1.2818	1.2808	1.1238	1.1226
WFI-1820-12	1 1/8	1 9/32	3/4	1.562	.078	1.1288	1.1254	1.2818	1.2808	1.1238	1.1226
WFI-1820-24	1 1/8	1 9/32	1 1/2	1.562	.078	1.1288	1.1254	1.2818	1.2808	1.1238	1.1226
WFI-2022-12	1 1/4	1 13/32	3/4	1.687	.078	1.2548	1.2508	1.4068	1.4058	1.2488	1.2472
WFI-2022-14	1 1/4	1 13/32	7/8	1.687	.078	1.2548	1.2508	1.4068	1.4058	1.2488	1.2472
WFI-2022-16	1 1/4	1 13/32	1	1.687	.078	1.2548	1.2508	1.4068	1.4058	1.2488	1.2472
WFI-2022-20	1 1/4	1 13/32	1 1/4	1.687	.078	1.2548	1.2508	1.4068	1.4058	1.2488	1.2472
WFI-2022-24	1 1/4	1 13/32	1 1/2	1.687	.078	1.2548	1.2508	1.4068	1.4058	1.2488	1.2472
WFI-2224-16	1 3/8	1 17/32	1	1.875	.078	1.3798	1.3758	1.5318	1.5308	1.3738	1.3722
WFI-2426-12	1 1/2	1 21/32	3/4	2.000	.078	1.5048	1.5008	1.6568	1.6558	1.4988	1.4972
WFI-2426-16	1 1/2	1 21/32	1	2.000	.078	1.5048	1.5008	1.6568	1.6558	1.4988	1.4972
WFI-2426-24	1 1/2	1 21/32	1 1/2	2.000	.078	1.5048	1.5008	1.6568	1.6558	1.4988	1.4972
WFI-2831-16	1 3/4	1 15/16	1	2.375	.093	1.7547	1.7507	1.9381	1.9371	1.7487	1.7471
WFI-2831-24	1 3/4	1 15/16	1 1/2	2.375	.093	1.7547	1.7507	1.9381	1.9371	1.7487	1.7471
WFI-2831-32	1 3/4	1 15/16	2	2.375	.093	1.7547	1.7507	1.9381	1.9371	1.7487	1.7471
WFI-3235-16	2	2 3/16	1	2.625	.093	2.0057	2.0011	2.1883	2.1871	1.9981	1.9969

* after pressfit. Testing methods ► page 55



Flange bearing

Dimensions [Inch]

Part number	d1	d2	b1	d3	b2	d1*		Housing bore		Shaft size	
						max.	min.	max.	min.	max.	min.
WFI-3235-24	2	2 3/16	1 1/2	2.625	.093	2.0057	2.0011	2.1883	2.1871	1.9981	1.9969
WFI-3235-32	2	2 3/16	2	2.625	.093	2.0057	2.0011	2.1883	2.1871	1.9981	1.9969

* after pressfit. Testing methods ► page 55



delivery available
time from stock



prices price list online
www.igus.eu/eu/w300



order part number
example WFI-3235-24

Thrust washer

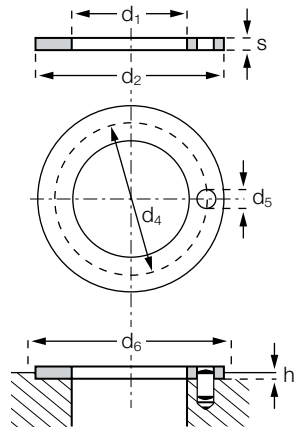
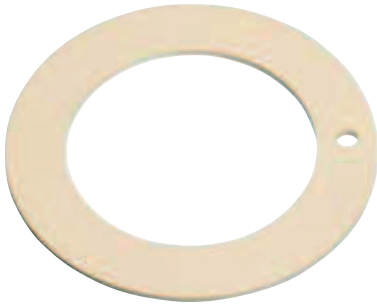

Order key

WTI-0814-01



Thickness s
Outer diameter d2
Inner diameter d1
Inch
Type (Form T)
Material iglidur® W300

Dimensions according to ISO 3547-1 and special dimensions

Dimensions [Inch]

Part number	d1 +.010	d2 -.010	s -.0020	d4 ±.005	d5 .015 + .005	h +.008	d6 +.005
WTI-0814-01	.500	.875	.0585	.692	.067	.040	.875
WTI-1018-01	.625	1.125	.0585	.880	.099	.040	1.125
WTI-1220-01	.750	1.250	.0585	1.005	.099	.040	1.250
WTI-1424-01	.875	1.500	.0585	1.192	.130	.040	1.500
WTI-1628-01	1.000	1.750	.0585	1.380	.130	.040	1.750
WTI-2034-01	1.250	2.125	.0585	1.692	.161	.040	2.125
WTI-2440-01	1.500	2.500	.0585	2.005	.192	.040	2.500
WTI-2844-01	1.750	2.750	.0585	2.255	.192	.040	2.750
WTI-3248-01	2.000	3.000	.0895	2.505	.192	.070	3.000

delivery available
time from stock

prices price list online
www.igus.eu/eu/w300

order part number
example WTI-0814-01